



## QEAM TM-21, TM-25, TM-30, AND TM-34 STRAP DRIVE MASTS OPERATING MANUAL



The Will-Burt Company  
401 Collins Blvd  
Orrville, OH 44667, U.S.A.

Phone: +1 330 684 4000  
E-Mail: [info@willburt.com](mailto:info@willburt.com)  
Website: [www.willburt.com](http://www.willburt.com)

TP-4619601-D, October 2023  
© 2023 The Will-Burt Company  
Original Instructions

Authorized Representative:  
Will-Burt Germany GmbH & Co. KG  
Fischergasse 25  
D-91344 Waischenfeld, Germany



## Warranty

Will-Burt warrants its mast system to be free from defects in material and workmanship for a period of two (2) years, with such time period running from the date of shipment by Will-Burt. Will-Burt shall not be responsible for any damage resulting to or caused by its products by reason of failure to properly install, maintain or store the product; use of the product in a manner inconsistent with its design; unauthorized service, alteration of products, neglect, abuse, accident, or acts of God. This warranty does not extend to any component parts not manufactured by Will-Burt; provided, however, Will-Burt's warranty herein shall not limit any warranties by manufacturers of component parts which extend to the buyer.

THE FOREGOING WARRANTY IS IN LIEU OF ALL OTHER WARRANTIES, AND NO REPRESENTATIONS, GUARANTEES OR WARRANTIES, EXPRESS OR IMPLIED, INCLUDING BUT NOT LIMITED TO, A WARRANTY OF MERCHANTABILITY, FITNESS FOR A PARTICULAR PURPOSE, OR NON-INFRINGEMENT ARE MADE BY WILL-BURT IN CONNECTION WITH THE MANUFACTURE OR SALE OF ITS PRODUCTS. NO EMPLOYEE, DISTRIBUTOR, OR REPRESENTATIVE IS AUTHORIZED TO CHANGE THIS WARRANTY IN ANY WAY OR GRANT ANY OTHER WARRANTY ON BEHALF OF WILL-BURT.

Claims for defects in material and workmanship shall be made in writing to Will-Burt within thirty (30) days of the discovery of defect. Failure to provide notice as required hereby shall be conclusive evidence that the product was in conformity with the warranty, and Will-Burt shall be released from any and all liability relating to the product. Will-Burt may either send a service representative or have the product returned to its factory at Buyer's expense for inspection. If judged by Will-Burt to be defective in material or workmanship, the product will be replaced or repaired at the option of Will-Burt, free from all charges except authorized transportation.

THE REMEDIES OF BUYER SET FORTH HEREIN ARE EXCLUSIVE AND ARE IN LIEU OF ALL OTHER REMEDIES. THE LIABILITY OF WILL-BURT WHETHER IN CONTRACT, TORT, UNDER ANY WARRANTY, OR OTHERWISE, SHALL NOT EXTEND BEYOND ITS OBLIGATION TO REPAIR OR REPLACE, AT ITS OPTION, ANY PRODUCT OR PART FOUND BY WILL-BURT TO BE DEFECTIVE IN MATERIAL OR WORKMANSHIP. WILL-BURT SHALL NOT BE LIABLE FOR COST OF INSTALLATION AND/OR REMOVAL, OR BE RESPONSIBLE FOR DIRECT, INDIRECT, SPECIAL OR CONSEQUENTIAL DAMAGES OF ANY NATURE.

## Document History

Document	Dates	Remarks
TP-5000901-00	4/3/2013	Initial Release
TP-4619601-C	12/2013	--
TP-4619601-D	10/23/2023	Updated to WB format

## Table of Contents

<b>Section 1 Safety Summary .....</b>	<b>vii</b>
1.1 Signal Word Definitions .....	vii
1.2 Safety Instructions .....	vii
1.3 Symbols .....	xiv
<b>Section 2 Introduction .....</b>	<b>2-1</b>
2.1 Intended Use .....	2-1
2.2 Definitions .....	2-2
2.3 Mast Component Descriptions .....	2-2
<b>Section 3 Technical Data .....</b>	<b>3-1</b>
<b>Section 4 Installation .....</b>	<b>4-1</b>
4.1 Pre-Installation Check .....	4-1
4.2 Select a Suitable Mounting Location .....	4-1
4.3 Recommended Installation Tools .....	4-2
4.4 Unpack the Mast System .....	4-2
4.5 Deploy the Mast .....	4-3
<b>Section 5 Retrieval .....</b>	<b>5-1</b>
5.1 Recommended Retrieval Tools .....	5-1
5.2 Retrieve the Mast .....	5-1
5.3 Optional Stake Puller .....	5-6
<b>Section 6 Transportation .....</b>	<b>6-1</b>
6.1 General Transportation .....	6-1
6.2 Shipping .....	6-1
<b>Section 7 Maintenance and Disposal .....</b>	<b>7-1</b>
7.1 Pre-Maintenance Check .....	7-1
7.2 Maintenance Equipment .....	7-1
7.3 Spare Parts .....	7-2
7.4 Periodic Maintenance .....	7-2
7.5 Strap Replacement Procedure .....	7-4
7.5.1 Strap Visual Inspection Criteria .....	7-4
7.5.2 Replace the Strap .....	7-8
7.6 Long-Term Storage .....	7-11
7.7 System Disposal .....	7-12
<b>Section 8 Mast Recovery Procedures .....</b>	<b>8-1</b>
8.1 Removing the Winch from an Extended Mast - Winch Issues .....	8-1
8.2 Mast Jammed in Extended Position .....	8-2
8.2.1 Standard Procedures .....	8-2
8.2.2 Emergency Procedure I .....	8-3
8.2.3 Emergency Procedure II .....	8-4

## Table of Figures

Figure 2-1 Accessory Bag S/A #1 Contents .....	2-3
--	-----

Figure 2-2 Accessory Bag S/A #2 Contents ..... 2-4

Figure 2-3 Accessory Bag S/A #3 Contents ..... 2-4

Figure 2-4 Accessory Bag S/A #4 Contents ..... 2-5

Figure 2-5 Accessory Bag S/A #5 Contents ..... 2-5

Figure 2-6 Accessory Bag S/A #6 Contents ..... 2-6

Figure 4-1 Shipping Crate (Not to Scale)..... 4-2

Figure 4-2 Orient Base Plate at Center of Site and Anchor with Four Base Plate Stakes ..... 4-3

Figure 4-3 Unwind Radius Rope in Direcion of Slot-Opening in Base Plate ..... 4-4

Figure 4-4 Hammer Guy Stakes at 60° Angle at Each Loop of Radius Rope ..... 4-4

Figure 4-5 Guying Diagrams ..... 4-6

Figure 4-6 Place the Base of the Mast on the Base Plate ..... 4-7

Figure 4-7 Insert Tupe A into Tube B..... 4-7

Figure 4-8 Slide the Legs into the Roller Frame ..... 4-7

Figure 4-9 Place Gin Pole Center Apprx. 3 ft From Center of Base Plate ..... 4-8

Figure 4-10 Place Lift Winch Directly Opposite the Mast ..... 4-8

Figure 4-11 Stake Lift Winch Bracket in Place..... 4-8

Figure 4-12 Tip Gin Pole Back Towards Lift Winch ..... 4-9

Figure 4-13 Connect Cable from Lift Winch to the Winch Shackle ..... 4-9

Figure 4-14 Tension the Lines Lightly by Placing Guy Tensioner Hook Over Double Guy Lines ..... 4-10

Figure 4-15 Lift the Lift Winch Up by its Carry Handle and Rotate Crank Handle Clockwise ..... 4-10

Figure 4-16 Attach Remaining Guy Lines ..... 4-11

Figure 4-17 Install the Manual Position or Top Tube Stub ..... 4-11

Figure 4-18 Raise Mast to Vertical..... 4-12

Figure 4-19 Adjust Four Base Guy Lines Using Bubble Level..... 4-12

Figure 4-20 Detach Positive Retraction Reel..... 4-12

Figure 4-21 Install Winch Bracket to Side of Mast ..... 4-12

Figure 4-22 Place Strap Winch Handle Over Strap Winch Post..... 4-13

Figure 4-23 Secure Winch at Desired Position ..... 4-13

Figure 4-24 Attach Positive Retraction Reel to Strap Winch ..... 4-13

Figure 4-25 Feed Strap from Mast Around Winch Idler Arm and Onto Strap Reel ..... 4-13

Figure 4-26 Place Strap Reel on Square Winch Shaft ..... 4-14

Figure 4-27 Attach Crank Handles to the Strap Winch at the Desired Reduction Shafts and 180° apart ... 4-14

Figure 4-28 When Using Cordless Drill to Extend Mast, Set Drill to Lowest Torque that Will Operate Mast ..... 4-15

Figure 4-29 When Guy Lines are Being Tensioned, Stand at Base of Mast and Site Mast for Vertical.. 4-16

Figure 5-1 Attach Crank Handles to the Crank Handle Input Shafts on the Winch ..... 5-1

Figure 5-2 Remove the Pin Attaching the Positive Retraction Reel to the Strap Winch..... 5-2

Figure 5-3 Remove Pin from the Square Winch Shaft..... 5-2

Figure 5-4 Remove the Positive Retraction Reel from the Strap Winch..... 5-2

Figure 5-5 Remove Pin Connecting the Strap Winch to the Strap Winch Bracket ..... 5-3

Figure 5-6 Remove Strap Winch from Winch Post of Mast ..... 5-3

Figure 5-7 Remove Strap Winch Bracket ..... 5-3

Figure 5-8 Add the Positive Retraction Strip and Pin in Place..... 5-3

Figure 5-9 Position Gin Pole in Place with Its Center 3 Feet from Base of Mast ..... 5-4

Figure 5-10 Crank Winch Counterclockwise .....	5-4
Figure 5-11 Remove All Guy Lines Except Two on the Base Tube .....	5-5
Figure 5-12 Hit Each Guy Stake on Each Edge and Use Hammer to Pry Under the Guy Line Hook Rib .....	5-5
Figure 5-13 Press Blue Button Then Insert the Pin to Connect Handle .....	5-6
Figure 5-14 Use the Cutouts that Best Fit Your Stake .....	5-6
Figure 5-15 Place Wide or Widest Cutout Over the Stake .....	5-6
Figure 5-16 Push Down on Stake Puller Handle .....	5-7
Figure 5-17 Place Narrow Cutout Over the Stake .....	5-7
Figure 5-18 Push Down on Stake Puller Handle .....	5-8
Figure 5-19 Lift Up on Handle .....	5-8
Figure 7-1 Periodic Inspections .....	7-2
Figure 7-2 New Strap will be Joined to Old Strap .....	7-8
Figure 7-3 Create a Butt Splice .....	7-8
Figure 7-4 Test the Splice .....	7-8
Figure 7-5 Remove Pulley Covers .....	7-9
Figure 7-6 Feed New Strap Without Twisting or Folding .....	7-9
Figure 7-7 Pull Loop of the Strap Out of the Largest Collar .....	7-9
Figure 7-8 Pull Out the Top Stub Cap .....	7-10
Figure 7-9 Pull Strap Out of the Top of the Mast .....	7-10
Figure 7-10 Secure Strap Pin in Place .....	7-11
Figure 8-1 Clamp Aluminum Clamp Block Over Strap .....	8-1
Figure 8-2 Crank Winch in Reverse Direction .....	8-1
Figure 8-3 Once Load has Been Fully Transferred to the Clamp Block, Winch can be Removed .....	8-2
Figure 8-4 Crank Winch in Reverse Direction to Transfer Load from Winch to Clamp Block .....	8-3
Figure 8-5 Put 1/8" Allen Wrench into Each Access Hold and Release Each of the Four Latches .....	8-5

## Table of Tables

Table 3-1 Mast Specifications .....	3-1
Table 4-1 Tools and Materials Required for Installation .....	4-2
Table 5-1 Tools and Materials Required for Installation .....	5-1
Table 7-1 Equipment Recommended for Maintenance .....	7-1
Table 7-2 Fraying Level of the Strap .....	7-4

(This page is intentionally left blank.)



# Section 1 Safety Summary

This section describes safety instructions for the QEAM Strap Drive Mast that personnel must understand and apply throughout all product activities such as transportation, handling, installation, deployment, disassembly, maintenance, storage, disposal and troubleshooting. Read and understand this entire document, and contact The Will-Burt Company with any questions, before performing any procedure outlined in this document. Keep this document during the entire duration of use of the device. Pass this document along to trained and qualified end users.

## 1.1 Signal Word Definitions

The following signal words and definitions are used to indicate hazardous situations:

### **DANGER**

**DANGER** indicates an imminently hazardous situation that, if not avoided, will result in death or serious injury.

### **WARNING**

**WARNING** indicates a potentially hazardous situation that, if not avoided, could result in death or serious injury.

### **CAUTION**

**CAUTION** indicates a potentially hazardous situation that, if not avoided, may result in minor or moderate injury. It is also used to alert against unsafe practices.

## 1.2 Safety Instructions

### **DANGER**

**Electrocution Hazard!** Contact with high voltage will result in death or serious injury. Observe general safety precautions for handling equipment using high voltage. Do not locate or operate mast near electrical lines, cables or other unwanted sources of electricity. Allow sufficient clearance on all sides of mast to allow for side sway. Do not operate mast during an electrical storm. Be certain electrical cables are undamaged and properly terminated. Do not touch live wires. Follow OSHA or other national safety regulations when working near energized power lines. Personnel working with or near high voltages should be familiar with methods of resuscitation.

### **DANGER**

**Disconnect Power for Service!** Always disconnect all power sources following proper lock-out tag-out procedures before performing service, repair or test operations. Remove the tethered hand held control where applicable for added protection during maintenance.

**⚠ DANGER**

**Mast Tip Over Hazard!** Mast tip over could result in death or serious injury. Before operation, be certain mounting structure is capable of resisting forces generated from all loading and environmental conditions, including, but not limited to, mast size and weight, payload and cable size and weight, payload sail area, wind speed, guy line arrangement, support bracket or roof line location, and base plate assembly. Do not operate in wind speed conditions exceeding the maximum rated wind speed. Do not operate on slopes exceeding the maximum deployment angle. Do not install a payload that exceeds the maximum payload lifting capacity of mast. Do not install a payload with the center of gravity offset from mast centerline exceeding the maximum allowed offset. Stand clear of mast and mast payload during operation. Be certain mast is level and secure before and during installation, operation, and maintenance.

**⚠ DANGER**

**Falling Objects from Mast Hazard!** Wear a protective hard hat when working on mast or situated near mast operating area while mast is extending, retracting or deployed in any position above the nested position. Improperly secured payload or mast components, ice formations, etc. could be dislodged from mast and fall. Be sure the payload is properly installed and secured.

**⚠ DANGER**

**Relocation/Driving Hazard!** Do not relocate the system during operation or while mast is extended to any height above the nested position or powered up. Do not move vehicle until mast has been securely nested and isolated from power. Power-up and operate mast only if the vehicle is stationary and securely parked with the parking brake properly applied. Do not put mast in service or operate without the vehicle interlock warning circuit or magnetic warning kit installed to provide confirmation mast is nested prior to moving the vehicle. Contact The Will-Burt Company Engineering for special on-the-move situations for military only use on specialized products.

**⚠ DANGER**

**Burst Hazard!** For pneumatically operated masts, do not operate without the over-pressure safety valve installed. Keep personnel clear of safety valve exhaust direction. Do not exceed the maximum rated pressure of mast. If the mast air pressure is not fully discharged prior to removing air hoses, a rapid release of air pressure will occur requiring hearing and eye protection.

**⚠ WARNING**

**Payload Lifting Hazard - Intended Use!** The mast is intended to lift a specific payload for lighting, surveillance or communication use only. Any other use without written consent is prohibited and could cause death or serious injury. Do not use mast to lift personnel. Do not exceed specified payload capacity. Large payload wind sail areas can reduce payload capacity. Consult The Will-Burt Company engineering.

**⚠ WARNING**

**Read Operating Instructions!** Read and observe the operating instructions. Non-observance of the instructions, operation which is not in accordance with use as prescribed in the instructions, wrong installation or incorrect handling can seriously affect the safety of operators and machinery. Adhere to the safety instructions when carrying out any activity relating to the mast.

**⚠ WARNING**

**Trained Personnel Only!** This product is intended for use by trained professionals only. It is not intended for general use by the public or untrained personnel. Handling, installation, operation and maintenance to be performed by trained and authorized personnel only. Only a properly trained and qualified certified electrician should perform electric installations and service.

**⚠ WARNING**

**Erratic Mast Operation Impact Hazard!** The mast should operate smoothly during extension and retraction. If erratic mast motion is observed during extension or retraction that results in impact loading between the tube and the tube collar (mechanical travel stop), cease use of the mast and contact The Will-Burt Company service department. Repeated operation with impact loading can damage tubes and lead to mast separation.

**⚠ WARNING**

**Over-current Protection!** Over-current protection or power switching by the installer on mast incoming power supply as specified in this document should be a type suitable to allow lock-out tag-out procedures for power disconnect.

**⚠ WARNING**

**Safety Instruction - Explosion!** For outdoor use only. Do not use in explosive areas or areas that have been classified as hazardous as defined in Article 500 of the National Electric Code or equivalent national standards. Do not use in the presence of flammable gases or liquids such as paint, gasoline or solvents. Do not use in areas of limited ventilation or where high ambient temperatures are present.

**⚠ WARNING**

**Safety Equipment (PPE)!** Proper personal protective equipment (PPE) like hard hats, gloves, and safety shoes shall be properly worn while working on mast or near the deployment area of mast. In addition, eye protection shall be worn during maintenance procedures. Follow national PPE guidelines in your area of operation.

**⚠ WARNING**

**Pinch Point Hazard!** Keep clear of all moving parts like mast collars nesting. Be sure to stay clear of system during operation. Moving parts can crush and cut resulting in serious injury. The mast shall be mounted out of reach of the operator during operation.

**⚠ WARNING**

**Crush Hazard - Mast Failure!** Do not stand directly beneath mast or its payload. Be certain the payload is properly installed and secured.

**⚠ WARNING**

**Entanglement Hazard!** Tangled cables can cause equipment damage. Ensure payload cables, Nycoil®, trip lines, guy lines or other cables are not tangled and are free to pay out as mast is deployed. Cables that get tangled or snagged on mast or other objects can cause mast tubes to lurch upward suddenly when the cable is freed. This can cause damage to mast and lead to mast separation if repeatedly allowed to continue.

**⚠ WARNING**

**Health and Safety Hazard while Cleaning!** Solvent used to clean parts is potentially dangerous. Avoid inhalation of fumes and prolonged contact to skin.

**⚠ WARNING**

**Fire Hazard Solvent!** Cleaning solvent, used for maintenance, is flammable and can be explosive. Do not smoke near solvent. Use cleaning solvent in a well-ventilated area. Keep cleaning solvent away from ignition sources. Always store cleaning solvent in the proper marked container and in a proper location.

**⚠ WARNING**

**Bright Light Radiation Hazard!** For systems equipped with scene lighting or look-up lights, do not look directly into lights when they are illuminated. Temporary impairment or permanent vision damage could occur.

**⚠ WARNING**

**Personnel Freezing/Burn Hazard!** If the system is equipped with lights, make sure the lights are completely cool before attempting to clean the lens, replace bulbs or perform maintenance. Wear gloves to protect from contact with exposed metal that may be at extremes of hot and cold temperatures from sun or cold outdoor exposure.

**⚠ WARNING**

**Mast Extension Hazard - Obstruction!** Extending mast into obstructions could result in death or serious injury and could render mast inoperable and partially extended. Before applying power and operating mast, be certain there is sufficient clearance above and to all sides of the expected location of the fully extended mast and payload. Keep all persons clear of mast and mast extension. Do not lean directly over mast. Locate the operator station such that the operator has a clear view of the operating space of mast and payload prior to deployment to avoid contact with overhead objects.

**⚠ WARNING**

**Manual Retraction!** For powered masts, make sure all power sources have been disconnected from the system prior to manually lowering mast to avoid unexpected start-up motion and/or damage to mast.

**⚠ WARNING**

**Mast Lifting/Handling!** Use extreme caution while lifting mast System and when mast System is suspended to avoid injury and equipment damage. Be certain mast is properly secured using at least two sling points at the center of gravity label. All operators should be aware of and follow the applicable local, regional, and national standards and codes of practice for slinging and transporting equipment. Never lift Mast System over people. Ensure lifting equipment including, but not limited to, lifting straps and hoist, are capable of handling the forces generated from lifting the system. Observe manufacturer instructions on lifting equipment.

**⚠ WARNING**

**Remove Payload!** For mast systems shipped with no payload (customer installed payloads), remove payload before performing maintenance on mast system. The Will-Burt Company installed devices can remain installed.

**⚠ WARNING**

**Equipment Damage - Submerged!** Do not submerge mast in liquid or operate the vehicle in a fording situation that would result in a submerged mast.

**⚠ WARNING**

**Safety Instruction – Keep Clear!** Keep personnel clear of the system during operation.

**⚠ WARNING**

**Safety Instruction - Potential Air Contaminants!** If internally mounted in a vehicle, air from mast and any accumulated water will discharge into the vehicle. Install appropriate drainage and venting.

**⚠ WARNING**

**Fastener Vibration Hazard!** Mast system and payload mounting hardware must include proper means to resist vibration loosening such as thread-locking compound, locking hardware, or equivalent. Use specified assembly torques appropriate for the fastener size.

**⚠ CAUTION**

**Safety Instruction - Guy Anchors!** For masts using Guy Lines, verify the Guy Anchor point strength is adequate to support the Guy Line forces.

**⚠ CAUTION**

**Frozen Water Hazard!** Water freezing inside mast or air fittings may render mast inoperable and cause major equipment damage such as tube deformation. Ensure water is free to exit at the base of mast. Open drain cock when mast is not in operation. The drain cock shall be installed at the lowest position in the pneumatic system. If mounted internally in a vehicle or structure, direct the draining water to a suitable location. Cover locking masts when not in use to limit water ingress. Non-locking masts stored outdoors should be covered if possible. A cover is available from The Will-Burt Company.

**⚠ CAUTION**

**Lubrication!** Do not lubricate the exterior of mast moving tubes. The lubricant will attract dust and other environmental contaminants into mast.

**⚠ CAUTION**

**Equipment Damage - Forces!** Before unloading the system, be certain the unloading region is capable of resisting forces generated from unloading the system including but not limited to system weight. Ensure the unloading region is level and has sufficient room and strength to hold the system. If the unloading region is incapable of meeting the requirements of the system, damage to the system and/or unloading region could occur.

**⚠ CAUTION**

**Equipment Damage - Support Bracket!** For masts using an upper support bracket, do not over-tighten mast support bracket. Over-tightening may damage the Base Tube causing mast tubes to stick.

**⚠ CAUTION**

**Mast and Payload Access!** The operator must provide safe means to access mast and payload during installation, removal and maintenance.

**⚠ CAUTION**

**Tripping Hazard!** Cables, trip lines, guy lines and guy anchors can be hard to see during and after installation. Any equipment posing trip hazards should be clearly marked.

**⚠ CAUTION**

**Lifting Hazard!** Depending on the mast model, the mast weighs up to 275 lbs. (125 kg). Always observe weight lift limits.

**⚠ CAUTION**

**Lubrication!** Do not apply oil or grease to the mast. Lubricants will attract sand/dirt and may lead to premature wear and/or damage to the strap.

**⚠ WARNING**

**Mast Extension Hazard!** Do not attempt to deploy the mast on ground that slopes more than 15° (26.8%). Do not attempt to deploy the mast on soft or loose soil. The base plate and guy stakes could become unstable under wind loading and cause the mast to fall. The mast must be vertical before deployment. Adjust guy lines as required until the bubble level indicates the mast is vertical.

**⚠ WARNING**

**Safety Instruction – Guy Stakes!** Always follow guy stake removal instructions to avoid injury and/or guy stake damage.

**⚠ WARNING**

**Mast Deployment and Retrieval Hazard!** Do not attempt to deploy or retrieve this mast during electrical storms or when winds exceed 25 mph (40 km/hr).

The following list contains reasonably foreseeable misuses of the mast system according to EN ISO 12100 5.3.2. These uses shall be avoided:

- Operating the mast with an obstruction in the functional space that prevents full extension or retraction
- Operating the mast near overhead power lines
- Operating the mast without the mast and operating space visible to the operator
- Driving the vehicle with the mast in a deployed position (any height above the nested position) or powered-up
- Operating the mast or leaving deployed in wind speeds higher than the specified maximum velocity
- Operating the mast on a non-level surface greater than the specified maximum angle
- Installing a payload greater than the maximum rated payload (weight and sail area) of the mast



### 1.3 Symbols

The following are symbols that may be used with the system and their meaning. Contact The Will-Burt Company with any questions before performing any procedure outlined in this manual.



This symbol indicates an electrocution hazard or hazardous voltage hazard. There is DC voltage present inside the mast and control box. Do not operate mast near electrical lines or during lightning events. Contact with high voltage will result in death or serious injury.



This symbol indicates a pinch point hazard. Keep fingers and hands clear of moving parts.



This symbol indicates a tip-over hazard. The mast must be properly supported during transport, installation, maintenance and operation. System tip-over could result in death or serious injury.



This symbol indicates a general warning. In this unit, this symbol indicates a frozen water hazard. Do not block the mast drain port at the base of the unit. Water must be permitted to exit the mast to avoid ice damage to the mast.



This symbol is used to remind users to read and understand the operator's manual before operating the Mast System. Failure to follow operating instructions could result in death or serious injury. Read and understand operator's manual before operating or installing the mast system.



This symbol indicates a hard hat is required when working under the mast operating area. Failure to wear a hard hat could result in death or serious injury.



This symbol indicates an electrical ground connection point.



This symbol is used to indicate the center of gravity (COG) of a fully nested mast.



## Section 2 Introduction

Thank you for selecting The Will-Burt Company for your critical payload elevation needs. These operating instructions describe transporting, handling, installing, disassembling, maintaining and storing procedures for the QEAM Strap Drive Mast. These procedures assume the use of standard mast systems. Procedures and characteristics for mast systems customized to meet customer-specific needs may vary.

These operating instructions are intended for professionals who are qualified by their appropriate training and experience to perform the procedures. Review this document in its entirety. Contact The Will-Burt Company with any questions before performing any procedure outlined in this manual.

The views depicted in this manual are provided for clarification and are subject to change without notice. Views are not to scale.

The QEAM Strap Drive Mast is designed for manual operation. It uses an internal strap wound between tube sections for mast elevation. The following models are covered in these operating instructions:

- QEAM TM-21 Strap Drive Mast
- QEAM TM-25 Strap Drive Mast
- QEAM TM-30 Strap Drive Mast
- QEAM TM-34 Strap Drive Mast

This manual is not for the following QEAM masts:

- QEAM MTS Series
- QEAM MTSV Series
- QEAM Screw Drive Masts

See [www.willburt.com](http://www.willburt.com) for information on these and other The Will-Burt Company products.

The QEAM Strap Drive Mast is available with many options installed by The Will-Burt Company, including the Gin Pole / Winch assembly.

### 2.1 Intended Use

The QEAM Strap Drive Mast is intended for use by professionals in the fire/rescue/first responder/security/towing/broadcast/cellular industries to provide elevated and directional emergency scene lighting and surveillance or communication capabilities. It is not intended for use by nonprofessionals. Do not use the mast to lift personnel. Contact The Will-Burt Company with any questions on the intended use or available training programs for installation and operation.

---

## 2.2 Definitions

The following terms are used throughout this manual:

- **Mast:** refers to the telescoping QEAM Strap Drive Mast
- **Mast System:** refers to the entire mast system and other optional accessories
- **Payload:** refers to the object or equipment being extended by the mast to an operational height

## 2.3 Mast Component Descriptions

This section describes major components of a mast system assuming the use of standard catalog mast systems. Characteristics of components customized to meet customer-specific needs may vary. If necessary, contact The Will-Burt Company for additional details.

The exact configuration of the mast may vary. For detailed information on the locations of components in your system, see the drawings that shipped with the system.

**Telescoping Mast:** The telescoping mast is the structure used to raise the payload to an operational level. It consists of a base tube, a top tube, and intermediate tubes that extend and retract.

**Strap Mast Tool Kit:** The Strap Mast Tool Kit is a kit that is mainly used during emergency nesting procedures and when repairing the mast strap. It contains vice grips, an Allen wrench set, a manual brake tool, and other components.

**Gin Pole / Winch Assembly (Optional):** The lift winch kit is used to raise the mast and payload from the horizontal position to the vertical position. It is also used to lower the mast and payload from the vertical position to the horizontal position. The lift winch and Gin Pole stabilize the mast and payload during installation and retrieval.

**Antenna Adaptor (Optional):** The antenna adaptor attaches to the top of the mast and is used to secure and support the payload during operation.

**Optional Stake Puller:** The optional stake puller is used to remove stakes. It can be used on different sizes of stakes including the 650mm and 850mm stakes. The stake puller top handle is shipped separate from the bottom base.

**Accessory Bags:** The accessory bags contain the components necessary for guying the mast. There are 6 different bags. Each mast (TM-21, TM-25, TM-30, and TM-34) has four to six accessory bags. The bags are referenced as “Accessory Bag S/A #1” through “Accessory Bag S/A #6”.

Mast	Accessory Bag S/A #1	Accessory Bag S/A #2	Accessory Bag S/A #3	Accessory Bag S/A #4	Accessory Bag S/A #5	Accessory Bag S/A #6
TM-21	4287801	4287802	4287803	4287804		4285306
TM-25	4293501		4293503	4293504	4293505	4285306
TM-30	4305001		4305003	4305004	4305005	4285306
TM-34	4285301	4285302	4285303	4285304	4285305	4285306

Figure 2-1 through Figure 2-6 show the parts in the accessory bags. For each mast, the parts may differ slightly because of the height of the mast. For example, the Accessory Bag S/A #3 for the TM-21 contains a 56' green and 100' tan tensioner. The Accessory Bag S/A #3 for the TM-25 contains a 56' green and a 75' tan tensioner.

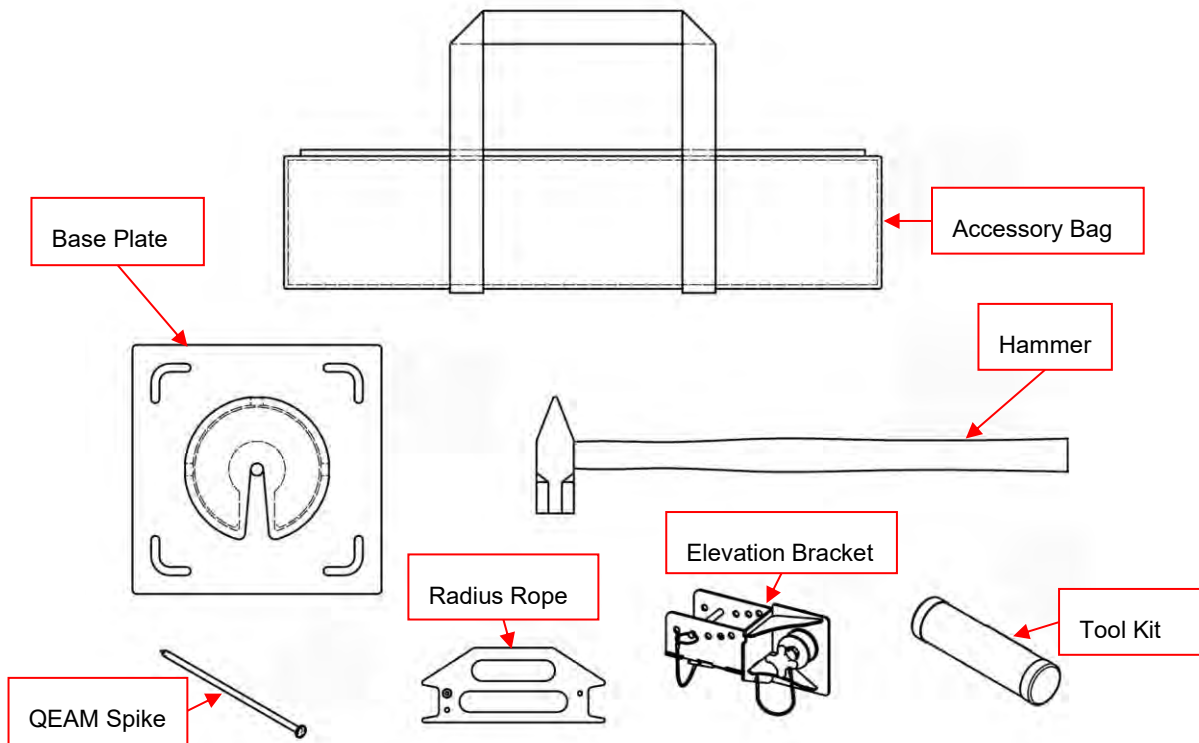


Figure 2-1 Accessory Bag S/A #1 Contents

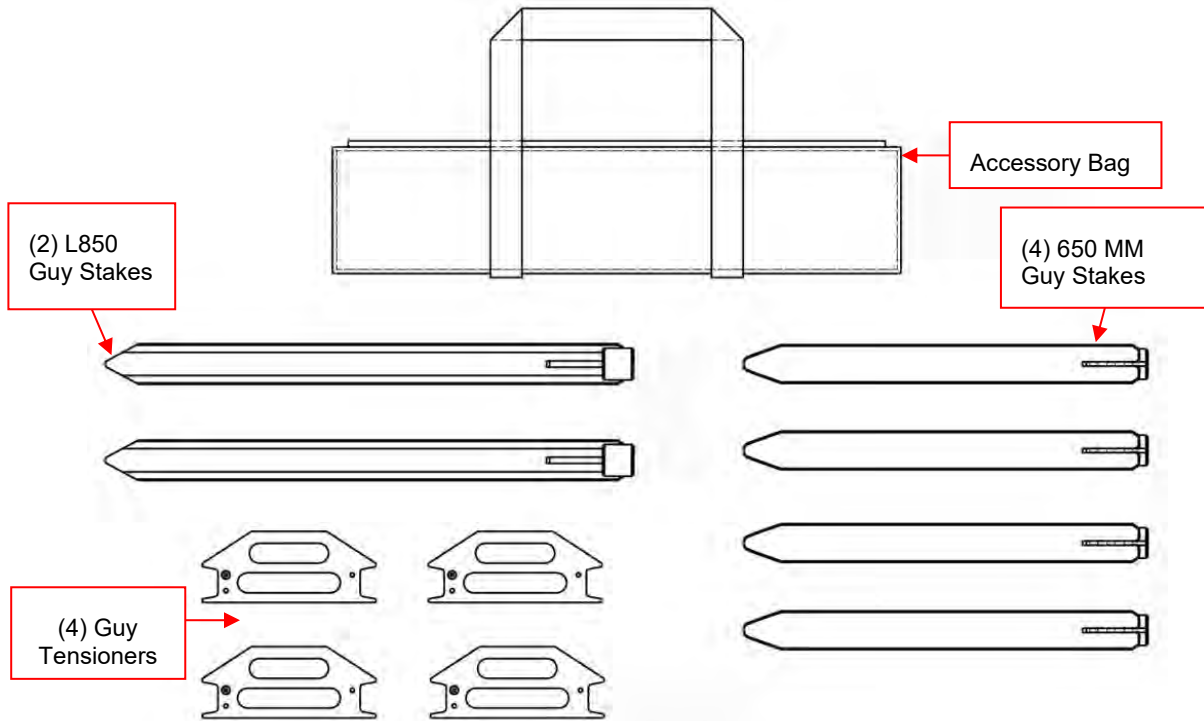


Figure 2-2 Accessory Bag S/A #2 Contents

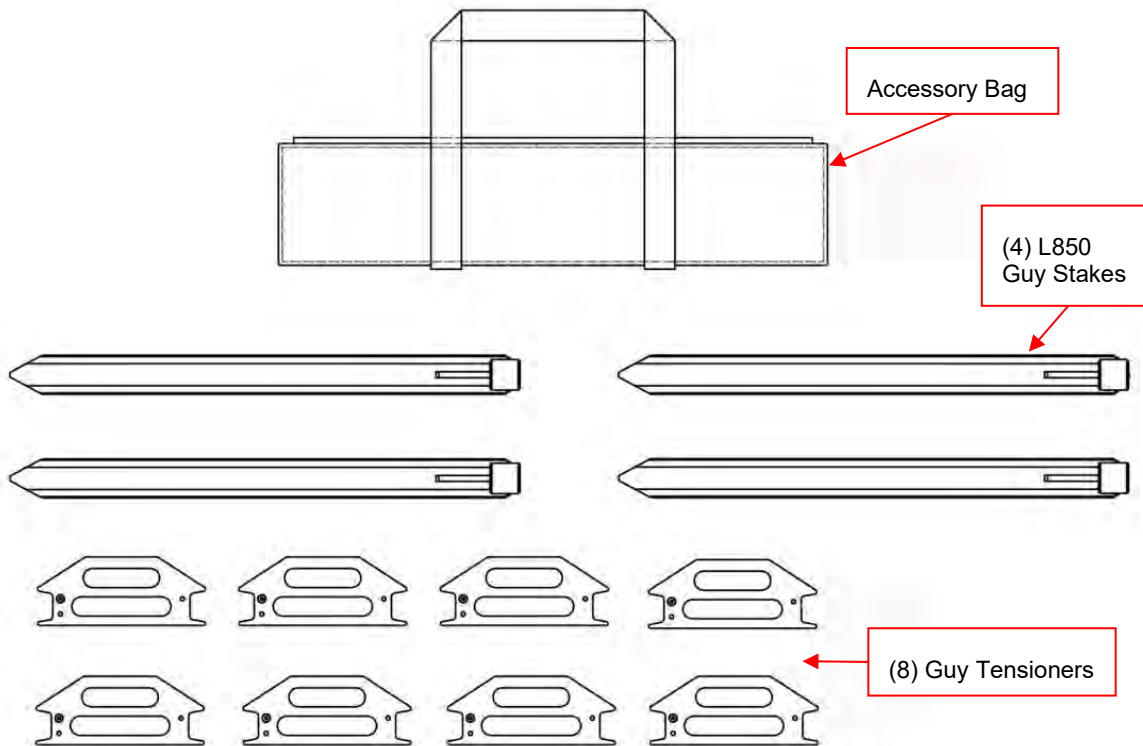


Figure 2-3 Accessory Bag S/A #3 Contents

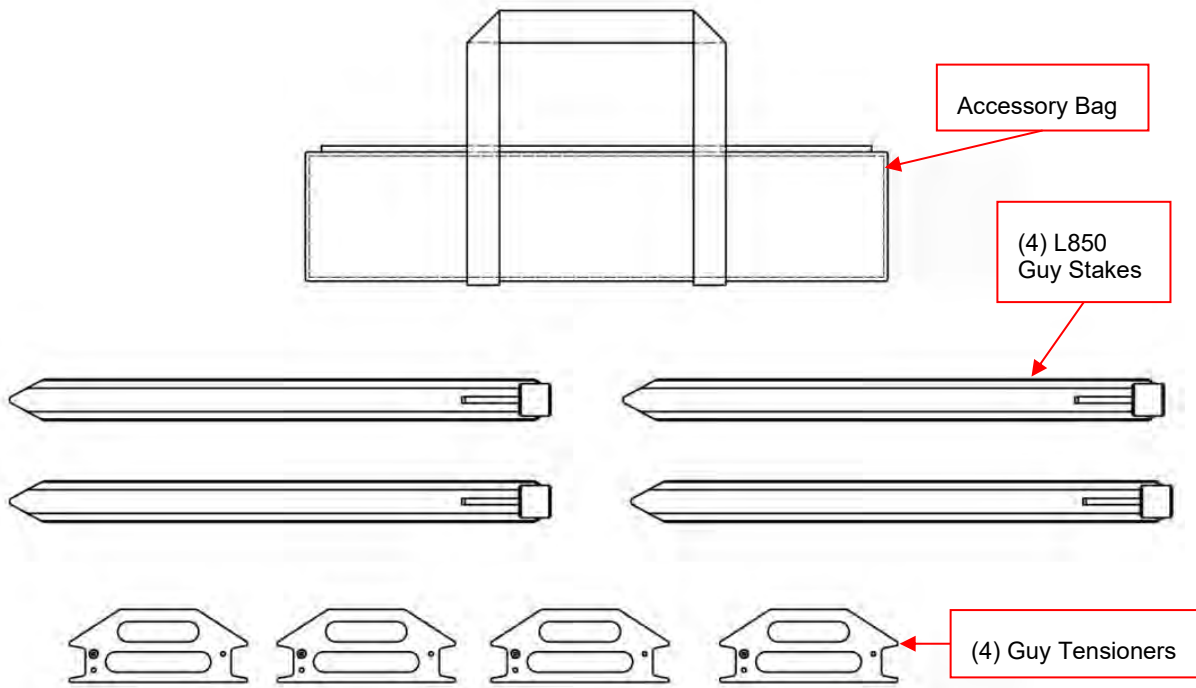


Figure 2-4 Accessory Bag S/A #4 Contents

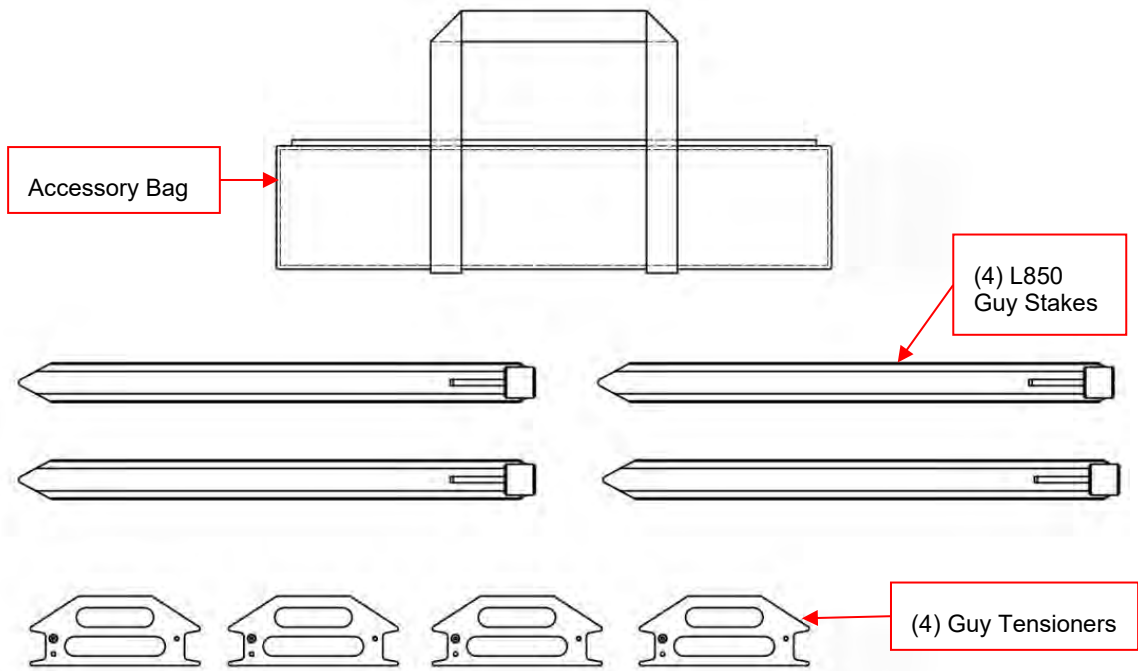


Figure 2-5 Accessory Bag S/A #5 Contents

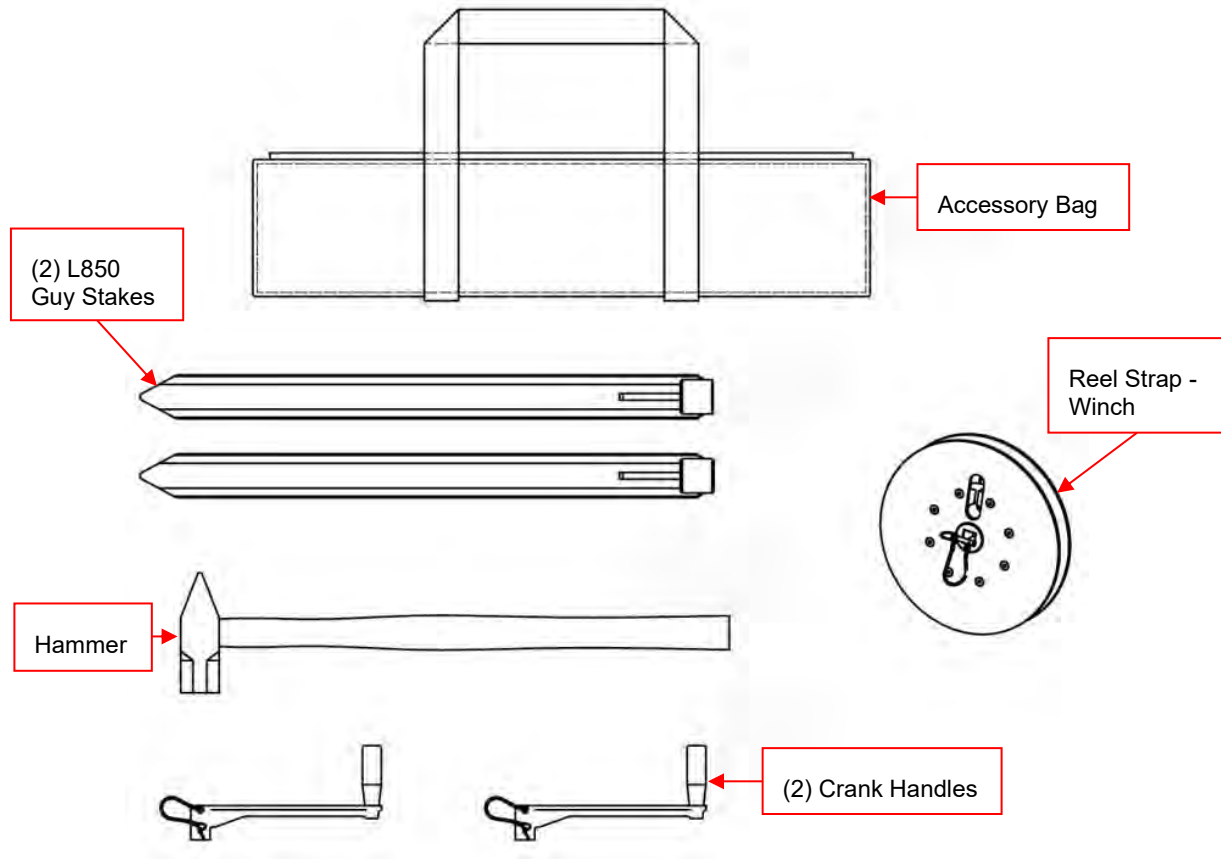


Figure 2-6 Accessory Bag S/A #6 Contents

## Section 3 Technical Data

Table 3-1 Mast Specifications

Aluminum Strap Drive Model	TM 21	TM 25	TM 30	TM 34
Nested Height	14.6 ft. / 4.45 m	14.8 ft. / 4.5 m	19.3 ft. / 5.9 m	19 ft. / 5.8 m
Extended Height	68.9 ft. / 21 m	82 ft. / 25 m	98.4 ft. / 30 m	112 ft. / 34 m
Guying	4 level / 4 way	5 level / 4 way	5 level / 4 way	5 level / 4 way
Number of Sections	6	7	6	7
Weight (Mast Only)	197 lb. / 90 kg	220 lb. / 100 kg	250 lb. / 114 kg	265 lb. / 121 kg
Weight (Accessory Kit)	245 lb. / 111 kg	275 lb. / 125 kg	275 lb. / 125 kg	275 lb. / 125 kg
Payload Capacity	180 lb. / 80 kg	150 lb. / 68 kg	150 lb. / 68 kg	110 lb. / 50 kg
Maximum Sail Area	6 sq. ft. / 0.6msq CD=1.5	6 sq. ft. / 0.6msq CD=1.5	6 sq. ft. / 0.6msq CD=1.5	6 sq. ft. / 0.6msq CD=1.5
Ice Load	0.5 in. / 12 mm	0.5 in. / 12 mm	0.5 in. / 12 mm	0.5 in. / 12 mm
Maximum Erection Wind *	25 mph / 40 km/h	25 mph / 40 km/h	25 mph / 40 km/h	25 mph / 40 km/h
Operational Wind	60 mph / 97 km/h	60 mph / 97 km/h	60 mph / 97 km/h	60 mph / 97 km/h
Survival Wind	80 mph / 128 km/h	80 mph / 128 km/h	80 mph / 128 km/h	80 mph / 128 km/h
Surface Mounting	±15° slope	±15° slope	±15° slope	±15° slope
Deployment Time	3 persons, 25 min	3 persons, 30 min	3 persons, 30 min	3 persons, 30 min
Drive System	Strap Drive	Strap Drive	Strap Drive	Strap Drive

\* Must be guyed for wind speeds over 25mph / 40km/h

Note:

- Payload Capacity assumes a Mast Deployment Angle 0° to 5°.
- Payload Capacity will be affected by wind sail area; consult factory. Payload Capacity includes cable weight.
- Dimensions and specifications provided are for reference only, and are not intended for vehicle design purposes.
- Specifications may be subject to change without notice.

(This page is intentionally left blank.)



## Section 4 Installation

This section provides instructions for installing the mast system and provides the general procedures that must be followed to ensure a successful installation. Be sure to read and understand the entire installation procedure and the Safety Summary (Section 1) before beginning installation.

### 4.1 Pre-Installation Check

Before installing the mast system, ensure:

- All installers read and understand the entire installation procedure and are properly trained.
- Only a properly trained and qualified certified electrician performs electric installations and maintenance.
- The mounting structure is level and has sufficient room and strength to mount the mast system.
- All purchased components are included (Section 2.3).
- All required equipment is readily available (Table 4-1).

Check with The Will-Burt Company's Engineering for additional wind information for customer-specific loading scenarios.

### 4.2 Select a Suitable Mounting Location

To select a suitable mounting location, consider the following:

- Select a flat, level site to deploy the system that has no more than a 15° (26.8%) slope. The ground should be level and firm.
- Ensure the ground is suitable for deployment of guy stakes and guy lines.
- Ensure the deployment site is at least 150 ft. (45 m) from overhead power lines or other overhead obstructions.

### 4.3 Recommended Installation Tools

Table 4-1 lists recommended tools and materials for installation.

*Table 4-1 Tools and Materials Required for Installation*

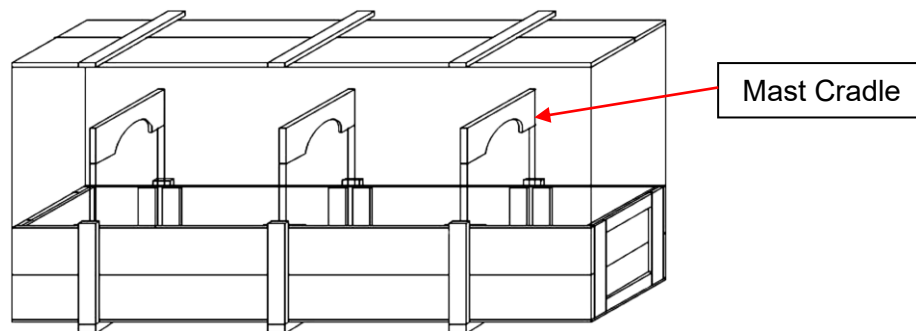
Tools and Materials		
Safety Glasses	Safety Shoes	Safety Gloves / Work Gloves
Hard Hat or Helmet	Level	Sling / Strap
Hammer (2)		
Note: Depending on the national and local standards and codes of practice, and the environment, additional personal protective equipment may be necessary.		

### 4.4 Unpack the Mast System

During installation, it will be necessary to lift the mast. The process described in this manual represents a possible method of lifting the mast. Depending on the environment and equipment available, other methods may work better. Use the best and safest method for your circumstances.

Unpack and handle the mast as follows:

1. Carefully open both shipping crates.
2. Inspect for any shipping damage. Notify the carrier if damage is evident.
3. Remove all loose components.
4. Ensure all components are included. Refer to Section 2.3 for part identification and quantity.
5. Remove the top half of the wooden cradles that secure the mast in place (Figure 4-1).



*Figure 4-1 Shipping Crate (Not to Scale)*

6. Outfit the mast with a sling and hoist capable of supporting the mast weight. The sling must support the mast from at least two points. Attach the sling at the center of gravity label so that horizontal balance and control can be maintained while positioning the mast.
7. Slowly lift the mast until just free of the mast cradles.
8. If necessary, lower the mast and adjust the sling as necessary to balance the mast.
9. Ensuring the sling does not catch on anything, lift the mast without any sharp or jerking motions until it is free of the shipping crate.
10. Slowly move the mast to the desired mounting location. The hoist operator should be able to view the mast at all times to ensure the mast does not collide with any obstructions.

The Will-Burt Company recommends keeping the shipping crate for transporting the mast, for example if shipping the mast back to the factory for refurbishment.

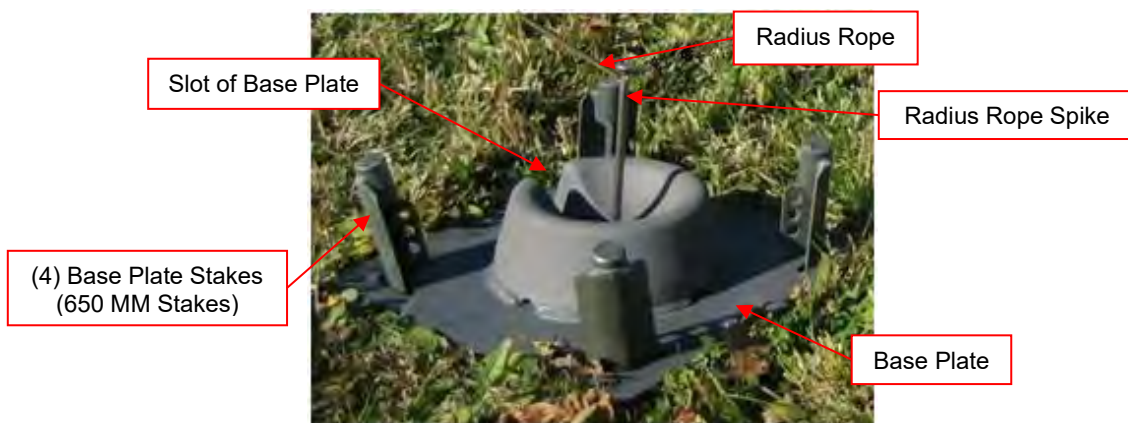
## 4.5 Deploy the Mast

This section describes how to deploy the mast system. The exact deployment procedures will vary based on the configuration of your mast system. Follow the appropriate deployment procedures for your mast system. Ensure the mast is only being operated in safe wind speeds.

Ensure the proper personnel are available to deploy the mast. At least 3 people are required.

To deploy the mast:

1. Orient the base plate at the center of the site and anchor with four base plate stakes (650 mm stake) (Figure 4-2).



*Figure 4-2 Orient Base Plate at Center of Site and Anchor with Four Base Plate Stakes*

2. Place the radius rope spike through the center of the base plate and hook loop #1 of radius rope to it.

- Unwind the radius rope in the direction of the slot-opening in the base plate (Figure 4-3).

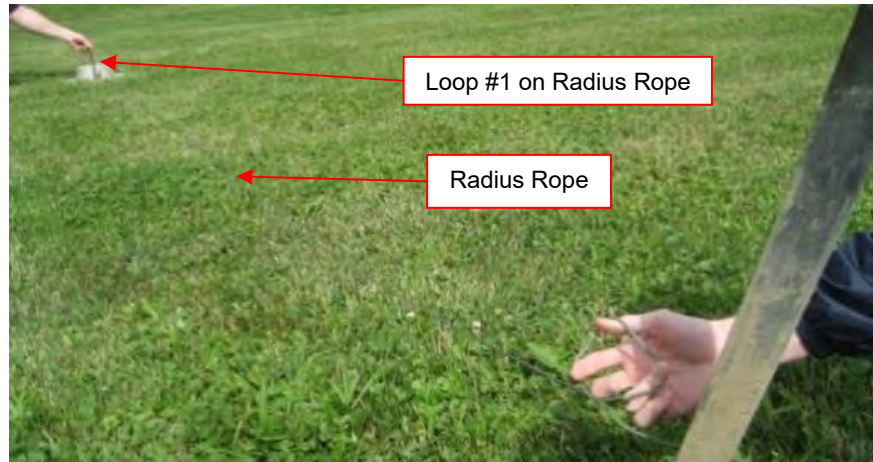


Figure 4-3 Unwind Radius Rope in Direction of Slot-Opening in Base Plate

- Hammer one (L850) guy stake at a 60° angle at each loop of the radius rope (total 3 for TM-21, total 4 for TM-25, TM-30, and TM-34) (Figure 4-4). Repeat this step for the remaining positions (90° apart).

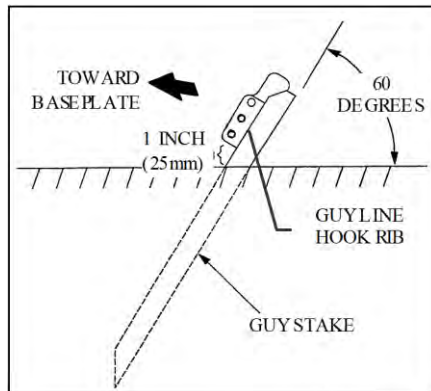
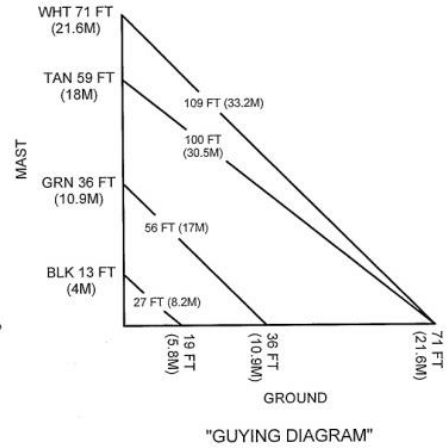
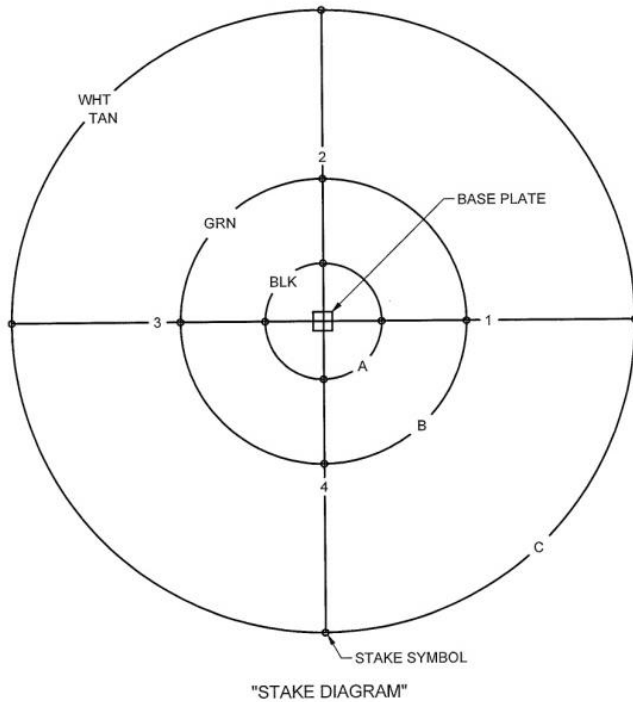
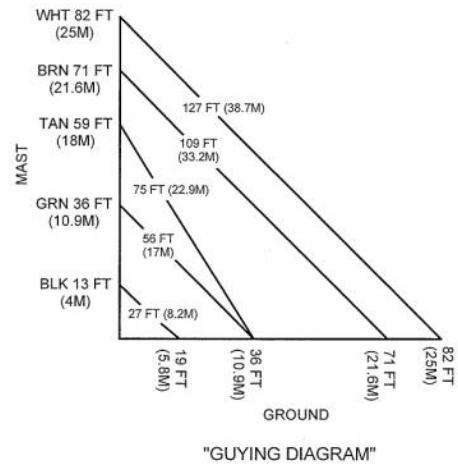
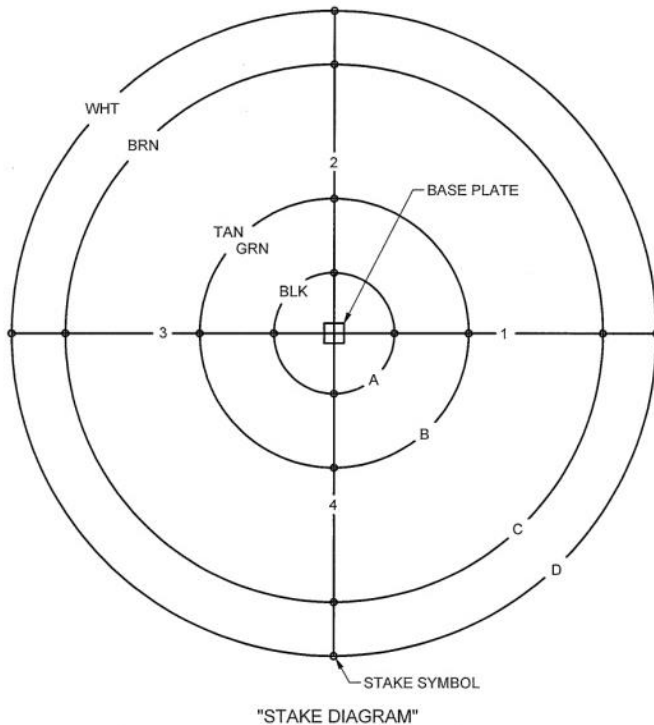


Figure 4-4 Hammer Guy Stakes at 60° Angle at Each Loop of Radius Rope

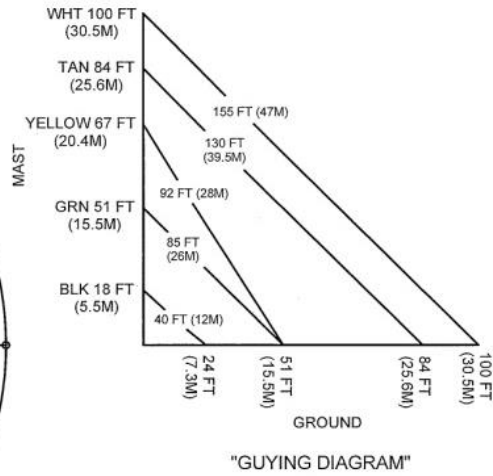
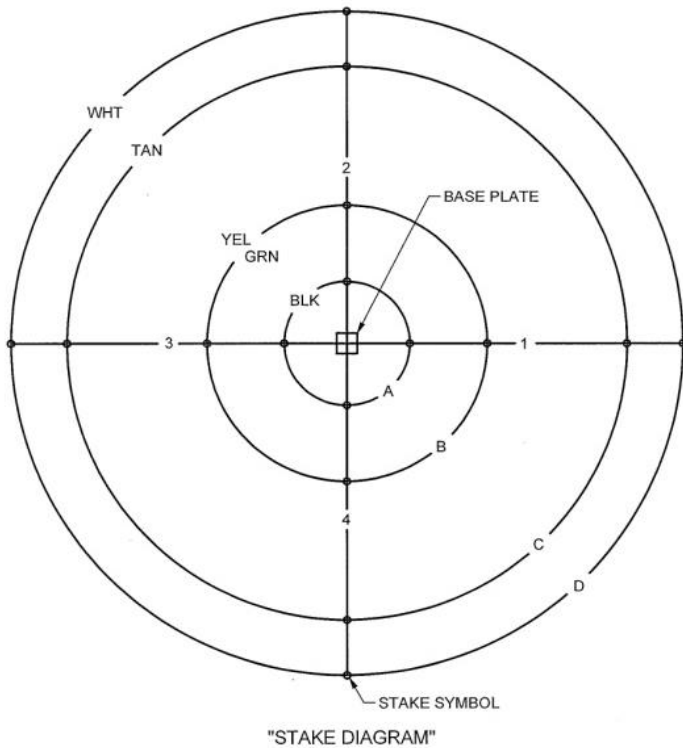
Below are guying diagrams for the mast system (Figure 4-5). Follow the appropriate diagram for your system.



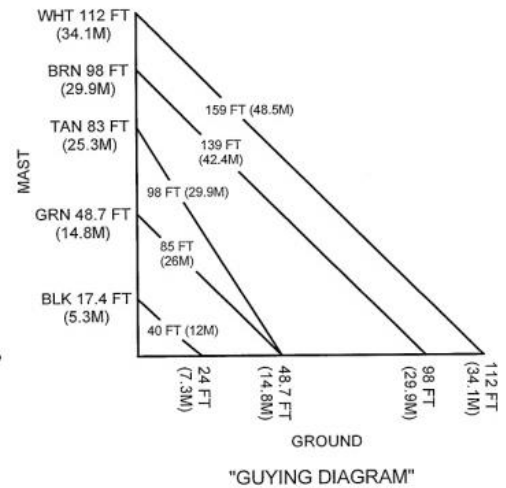
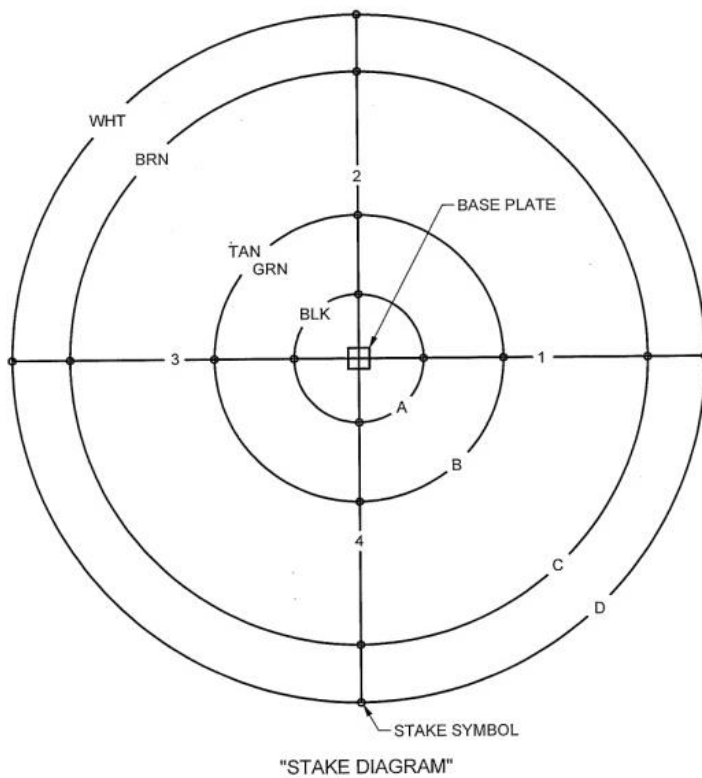
**21M**



**25M**



# 30M



# 34M

Figure 4-5 Guying Diagrams



Steps 5 through 13 describe installing the optional Gin Pole / Winch assembly.

If the optional Gin Pole / Winch assembly is not being installed, skip to Step 14.

- Place the base of the mast on the base plate with the guide rib engaged in the slot and lay the top end of the mast on the ground (if oriented properly, the winch shackle will be facing upward). The guide rib can be identified as the rib that has the most angular separation from the other ribs. Connect the safety linkage (included with the optional gin pole kit) on each side of the base of the mast to the top holes of the base plate stakes. Be sure to attach the safety linkage to the two base plate stakes nearest the top of the mast (Figure 4-6):



Figure 4-6 Place the Base of the Mast on the Base Plate

- Remove the tube legs from the carry bag and insert Tube A (tube with foot) into Tube B (tube without foot). Be sure the key of Tube B inserts into the slot of Tube A. Repeat three times to have a complete set of 4 assembled legs (Figure 4-7).
- Slide each of the four assembled legs into the roller frame and ensure each tube contacts on the stop. Hand-tighten the wing nuts inside the roller frame to fasten the legs to the frame (Figure 4-8).

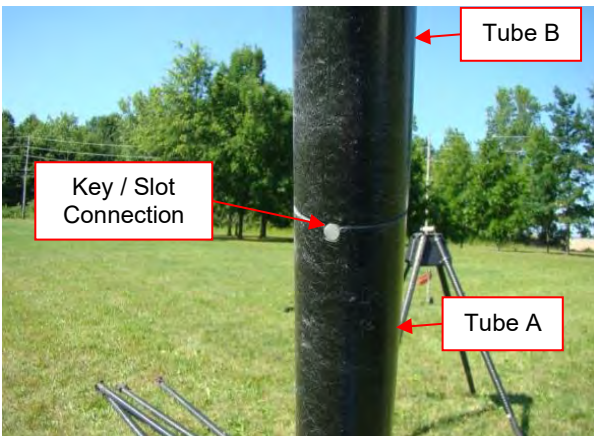


Figure 4-7 Insert Tube A into Tube B

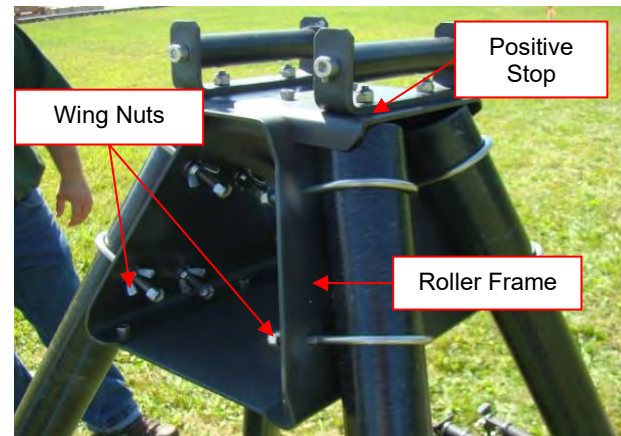


Figure 4-8 Slide the Legs into the Roller Frame

8. Place the center of the assembled gin pole approximately 3 ft. (1 m) from the center of the base plate, opposite the top of the mast. Be sure the roller frame of the gin pole is in-line with the mast and also in-line with the 4 previously placed guy stakes opposite the mast (Figure 4-9).
9. Place the lift winch directly opposite the mast with the lift winch chains in a direction opposite the mast. The carabiner of these chains should be approximately 3 ft. (1 m) inside the first guy stake opposite the mast. Note the orientation of the lift winch with regard to the mast and gin pole (Figure 4-10).

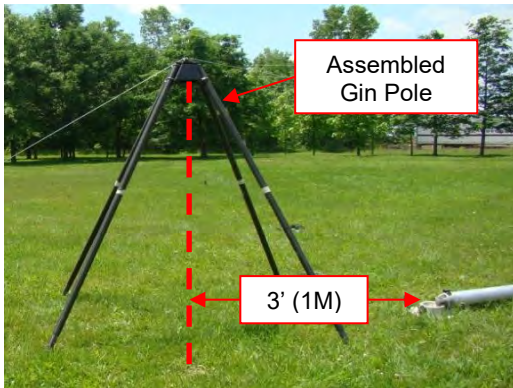


Figure 4-9 Place Gin Pole Center Apprx. 3 ft From Center of Base Plate

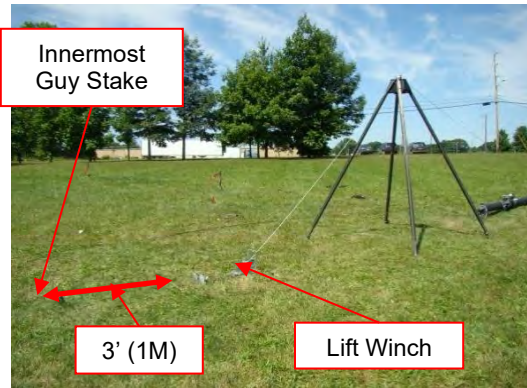


Figure 4-10 Place Lift Winch Directly Opposite the Mast

10. Stake the lift winch bracket in place by placing two (L850) guy stakes in the area of the lift winch chain carabiner. Place these stakes only 4 to 8 inches apart otherwise the winch handles may hit the winch chains (Figure 4-11). These stakes should be hammered into the ground at a 60° angle as shown in Figure 4-4. Once the stakes are securely in place, attach the two lift winch chain carabiners to the top hole of these stakes, making sure not to cross them.

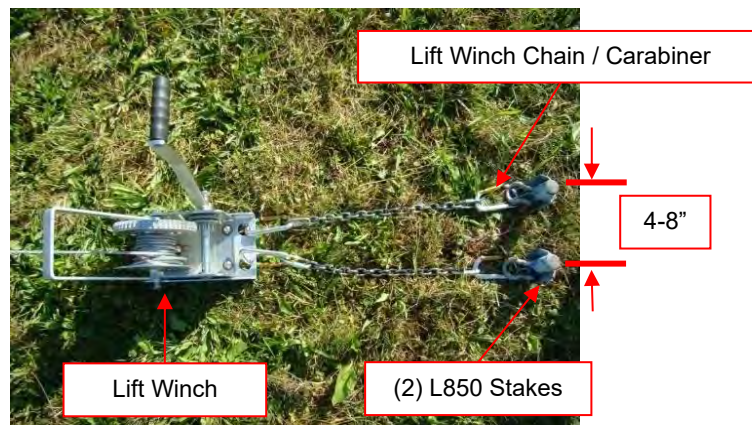


Figure 4-11 Stake Lift Winch Bracket in Place



11. Unwind enough cable from the lift winch to reach the base of the mast. The lift winch has a brake on it, preventing the cable from simply being pulled from it. To unwind cable from it, the crank handle must be rotated in a counterclockwise direction (when looking at the lift winch from the side of the handle). Tip the gin pole back towards the lift winch and place the cable in the middle of the roller frame (Figure 4-12). Stand the gin pole back up - the cable should now be in place over the top of the rollers of the erected gin pole.
12. Unwind enough cable to reach the winch shackle on the base tube collar of the mast. Connect the cable from the lift winch to the winch shackle. Ensure that the opening end of the winch shackle (shown in yellow) is facing the mast to avoid denting the base tube (Figure 4-13).

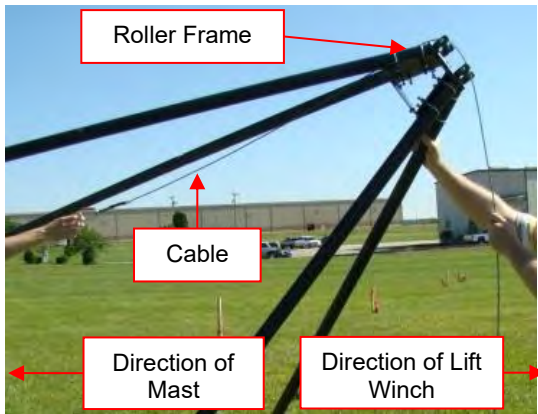


Figure 4-12 Tip Gin Pole Back Towards Lift Winch

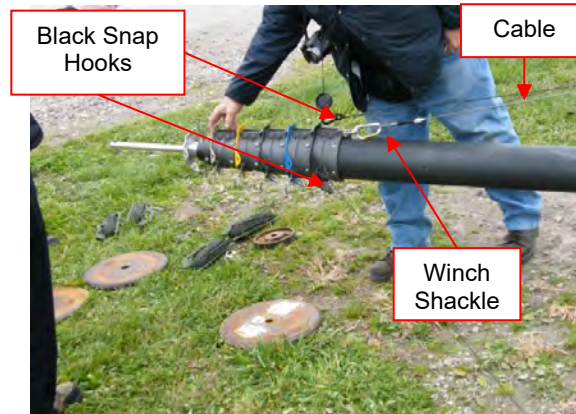


Figure 4-13 Connect Cable from Lift Winch to the Winch Shackle

13. Unwrap two guy tensioners with black snap hooks and attach (a) the black snap hooks of these tensioners to the side position (90° to each side of the winch shackle) of the lowest guy plate (black) on the mast and (b) the green snap hooks of these tensioners to the lowest hole on the innermost guy stakes. Be sure the snap hooks attached to the guy plates of the mast are in-line (on the same side) with the snap hooks attached to the guy stakes to prevent tangling of the guy lines. Note that the snap hooks should be fastened from underneath the guy plates.

14. Tension the lines lightly by sliding the tensioner toward the mast and lock it by placing the guy tensioner hook over the double guy lines (Figure 4-14).

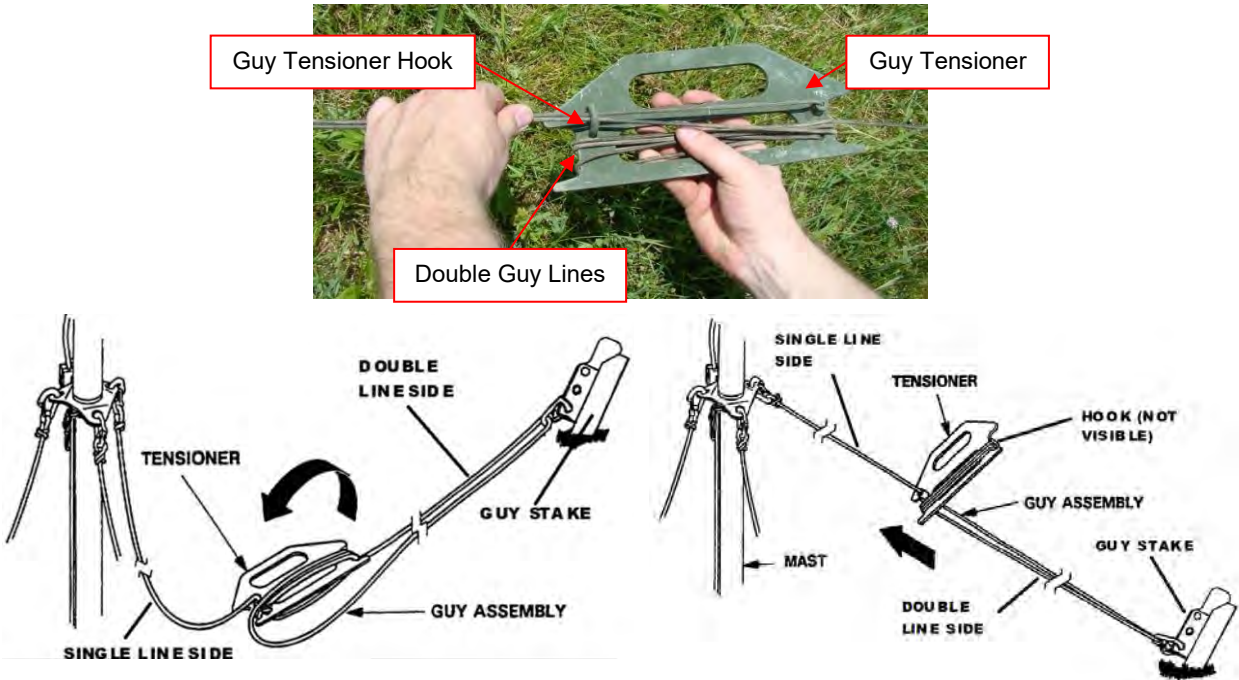


Figure 4-14 Tension the Lines Lightly by Placing Guy Tensioner Hook Over Double Guy Lines

15. Lift the lift winch up by its carry handle and rotate the crank handle in a clockwise direction (when looking at the lift winch from the crank handle side) to raise the top of the mast to a convenient working height for loading the payload and attaching the remaining guy lines (about 4 ft. (1.2 m)). To better steady the lift winch during this operation, slide the handle of the sledgehammer through the carabiners of the connecting chains and apply a slight downward force. At all times during the winching operation, verify that the winch cable remains taut and in the center of the gin pole roller frame, that the mast remains in the "dish" portion of the base plate, that the guide rib of the mast remains in the slot of the base plate, and that the winch stakes are stable and do not move more than 3 in. (75 mm) (Figure 4-15).

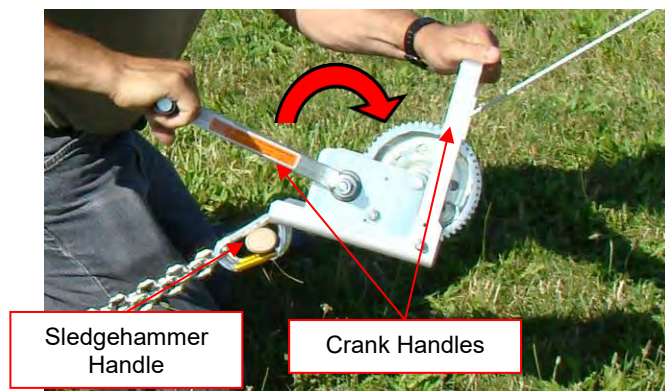


Figure 4-15 Lift the Lift Winch Up by its Carry Handle and Rotate Crank Handle Clockwise

16. Unwind and attach all of the remaining guy lines to the matching color-coded guy plates (Figure 4-16). Note that some guy plates may not be used (optional guying levels). Note that the payload or the top of the mast must always be guyed. The guy lines can be attached directly to the payload or various options are available for top level guying, including a torque arm or a 50mm stub with a guy plate.
17. Install the manual positioner or top tube stub (if supplied) into the top of the mast and pin it in place using the integrated quick-release pin (Figure 4-17).



Figure 4-16 Attach Remaining Guy Lines



Figure 4-17 Install the Manual Position or Top Tube Stub

18. Install the payload onto the manual positioner/top tube stub and secure it.
19. Place the cable(s) through the cable guides and attach to the payload as required. If the optional gin pole/winch assembly is not being used to erect the mast, skip to step 22.
20. Begin raising the mast to a vertical position with the lift winch. Verify that the side guy lines are not binding and that the mast remains in-line with the lift winch cable.
21. In order to prevent the mast from falling over (in the direction of the winch) as it reaches vertical, it is critical that the guy line opposite the lift winch be set to length. Follow the following steps in order to accomplish this task.
  - a. Connect the green snap hook of this black tensioner to either one of the side (90° from either side of the winch shackle) innermost guy stakes.
  - b. Tension the line lightly by sliding the tensioner toward the mast and lock it by placing the guy tensioner hook over the double guy lines.
  - c. Disconnect the green snap hook of this tensioner from the guy stake it is currently connected to and attach it to the innermost guy stake directly opposite the lift winch (in-line with the guy ring of the guy plate).

This procedure sets the length of this guy line at the approximate length necessary to allow the mast to be raised to the vertical position. It is critical that personnel be stationed on this guy line during the raising of the mast (from horizontal to vertical) in order to make the necessary adjustments to its length to (1) allow the mast to reach vertical and (2) prevent it from over-travelling the vertical position.



22. Raise the mast to vertical and verify that the mast is securely seated on the base plate (Figure 4-18).
23. Using the integrated bubble level, adjust the four base guy lines using the black tensioners until all are tight and the mast is vertical. The bubble must be completely inside the inner circle of the bubble level before the mast is deployed (Figure 4-19).



Figure 4-18 Raise Mast to Vertical

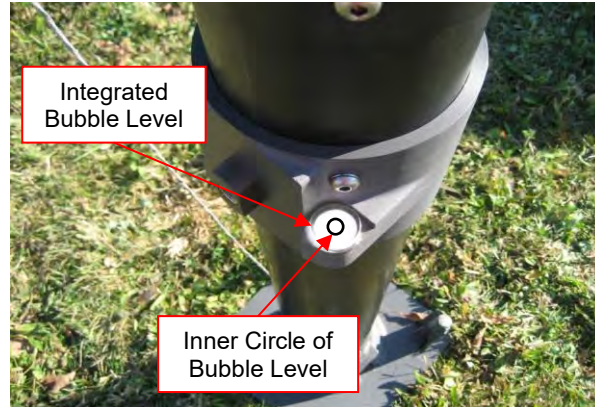


Figure 4-19 Adjust Four Base Guy Lines Using Bubble Level

24. Using the rotator/tilter ropes (if supplied), position the payload as nearly as possible to its required position. Final adjustment will be made after the mast is extended.
25. If applicable, remove the gin pole from the area (move it outside of the furthest guy stake) to allow more room to properly and efficiently deploy the mast.
26. Detach the positive retraction reel from the winch post and set it beside the mast (Figure 4-20).
27. Install the winch bracket to the side of the mast using the attached hand knob (Figure 4-21).

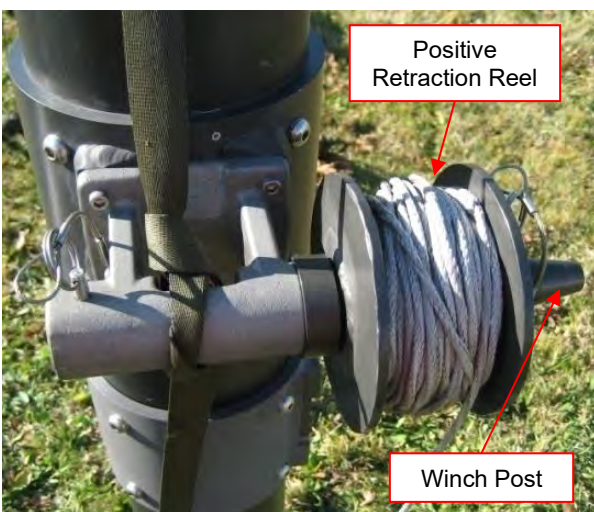


Figure 4-20 Detach Positive Retraction Reel

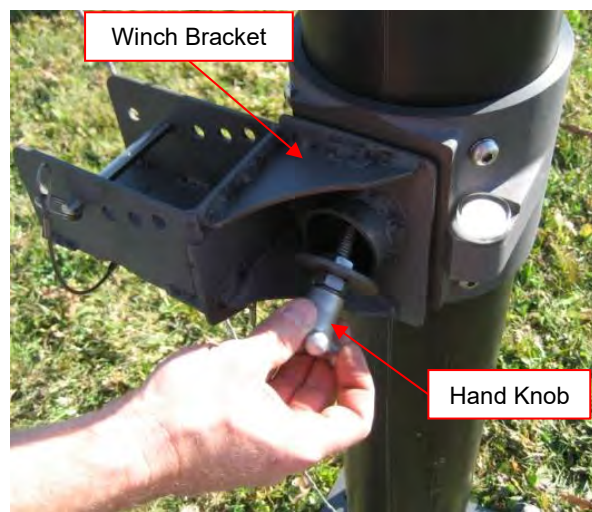


Figure 4-21 Install Winch Bracket to Side of Mast

28. Lift the strap winch to the position shown and place the hole in the handle of the strap winch over the winch post. Note: This is a 2-person lifting operation (Figure 4-22).
29. Adjust the strap winch (focusing mainly on the crank handle input shafts) to the desired height and using the pin attached to the winch bracket, fix the winch at that position (Figure 4-23).

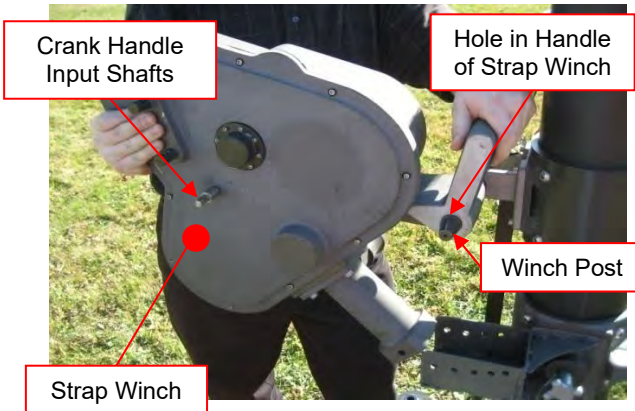


Figure 4-22 Place Strap Winch Handle Over Strap Winch Post



Figure 4-23 Secure Winch at Desired Position

30. Attach the positive retraction reel to the strap winch. Spin it to remove any slack from the rope and then secure it to the strap winch using the attached pin (Figure 4-24).
31. Feed the strap from the mast around (under) the winch idler arm and onto the strap reel in the direction shown. The strap must slide into the slot in reel and the knot must be set in the hole at the base of the slot (if the strap does not have a knot, tie one approximately 2 in (50mm) from the end) (Figure 4-25).



Figure 4-24 Attach Positive Retraction Reel to Strap Winch

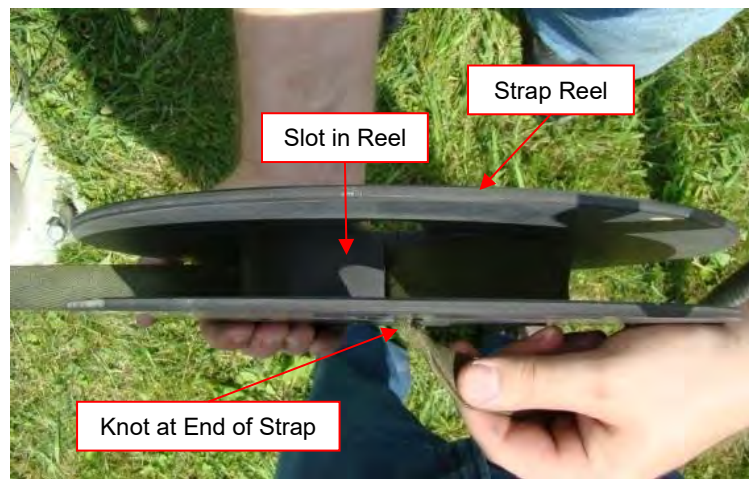


Figure 4-25 Feed Strap from Mast Around Winch Idler Arm and Onto Strap Reel



32. Place the strap reel on the square winch shaft so that the strap is centered between the walls of the reel and install the pin to prevent accidental removal (Figure 4-26).

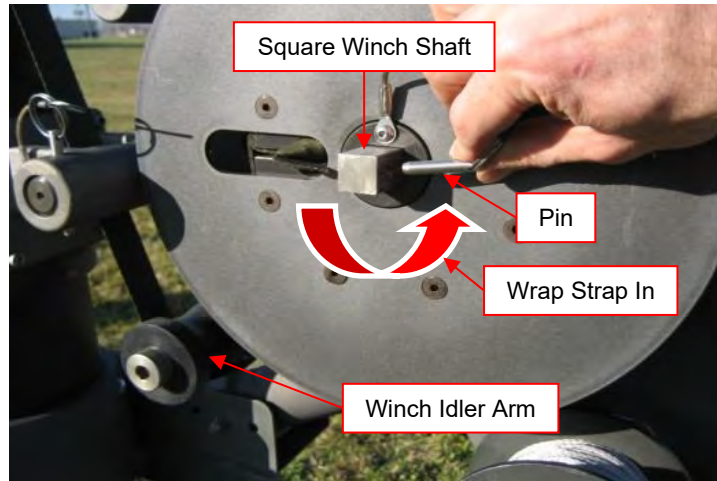


Figure 4-26 Place Strap Reel on Square Winch Shaft

33. Attach the crank handles to the strap winch at the desired reduction shafts (“high speed” in most cases) and 180° apart. Secure the crank handles using the attached pins. Crank the handles in the indicated direction (per the label on the strap winch) to raise the mast. When cranking the handles, be sure to visually inspect the condition of the strap as it spools around the reel to ensure it is in good working condition. Refer to Section 7.5.1 for strap visual inspection criteria to verify the strap is in good working condition (Figure 4-27).



Figure 4-27 Attach Crank Handles to the Strap Winch at the Desired Reduction Shafts and 180° apart

34. When using a cordless drill to extend the mast, do not install the crank handles. An 18 volt or larger cordless drill can be chucked directly to the drill input (a 3/8 inch hex). The clutch on the drill should be set to the lowest torque that will operate the mast to avoid breaking the shear pin in the hex input (Figure 4-28). If the shear pin does break, there are replacement pins in the tool kit.



*Figure 4-28 When Using Cordless Drill to Extend Mast, Set Drill to Lowest Torque that Will Operate Mast*

35. Under windy conditions, more torque will be required to extend the mast, especially when a section is nearing full extension. If available, deploy two personnel to the appropriate upper guy lines to pull the mast into the wind and straighten it. This will reduce the torque required for deployment. Do not attempt to deploy the mast if winds exceed 25 mph (40 km/hr).
36. When a section with guy lines attached reaches full extension, the vertical deployment of the mast must stop in order to secure the guy lines. There are a few key indicators that help determine when a section has reached full extension:
- An increase in torque required to raise the mast.
  - A distinct noise indicating the engagement/deployment of the next section of the mast.
  - Visually observing the next section of the mast starting to deploy.

37. The guy lines must be secured to the appropriate guy stakes and tensioned before the mast is extended any further. Stand at the base of the mast and site the mast for vertical as the guy lines are tensioned (Figure 4-29).



*Figure 4-29 When Guy Lines are Being Tensioned, Stand at Base of Mast and Site Mast for Vertical*

38. The mast has built-in stops but can be extended to any intermediate height. Always deploy the guy lines on the extended sections and the payload (or top adapter) before leaving the mast, even when the mast is only partially extended. The full height of the mast is realized when:
- All sections of the mast are observed to be extended.
  - The crank handles of the strap winch become very difficult to crank.
39. Once the mast has reached the desired height, stop cranking to automatically engage the strap winch lock. The crank handles can be removed at this time if desired.
40. Visually check that the mast is straight in all directions and adjust the guy tensioners as required to straighten the mast.
41. The rotator/tilter ropes (if supplied) may now be used to reposition the payload. The ropes should be tied off to the mast when they are not in use.



## Section 5 Retrieval

This section provides instructions for retrieving the mast system and provides the general procedures that must be followed to ensure a successful retrieval. Be sure to read and understand the entire retrieval procedure and the Safety Summary (Section 1) before beginning retrieval.

### 5.1 Recommended Retrieval Tools

Table 5-1 lists recommended tools and materials for installation.

*Table 5-1 Tools and Materials Required for Installation*

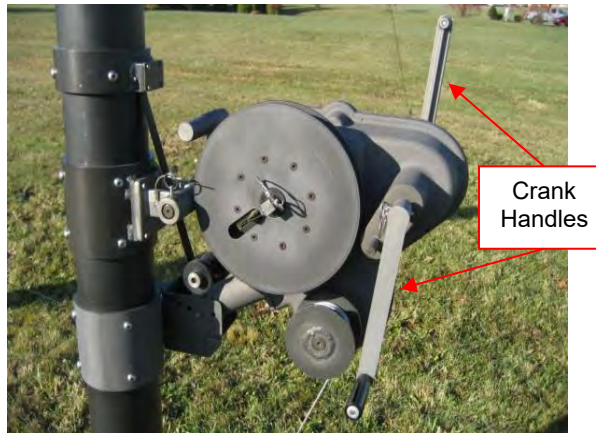
Tools and Materials		
Safety Glasses	Safety Shoes	Safety Gloves / Work Gloves
Hard Hat or Helmet	Sling / Strap	Level
Hammer (2)		
Note: Depending on the national and local standards and codes of practice, and the environment, additional personal protective equipment may be necessary.		

### 5.2 Retrieve the Mast

Note: Verify that winds do not exceed 25 mph (40 km/hr). Do not attempt to retrieve the mast in winds exceeding 25 mph (40 km/hr).

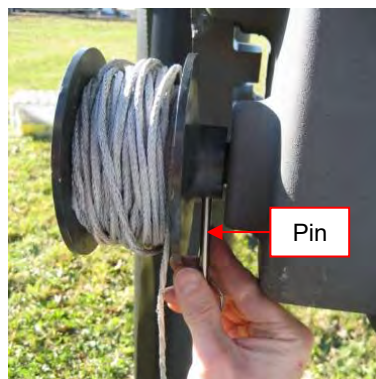
To retrieve the mast, proceed as follows:

1. Attach the crank handles to the crank handle input shafts on the winch and crank the handles in the indicated direction to retract the mast. The positive retraction mechanism will automatically engage as required to help retract the mast. The handles may become more difficult to crank for brief periods, this is normal. The additional torque required is an indication that the mast positive retraction is engaged. Some noise and vibration may also be evident. This is normal operation of the positive retraction clutching mechanism.



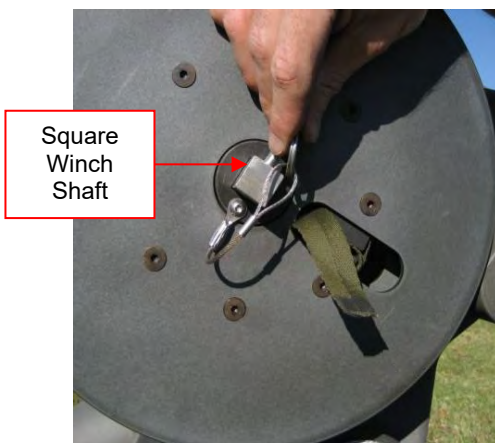
*Figure 5-1 Attach Crank Handles to the Crank Handle Input Shafts on the Winch*

2. When a mast section being retracted is approaching a guyed mast section (within 3 ft. (1 m)), it is beneficial to relieve the tension of all 4 guy lines of the guyed section. This helps the section above nest into the guyed section without binding.
3. Under windy conditions, it is helpful to deploy two people to the appropriate upper guy lines to pull the mast into the wind and straighten it. This will reduce the torque required for retraction.
4. Continue cranking the winch in the retraction direction, being sure to release the tension on the guy lines of the guyed sections as the sections above are within 3 ft (1 m). When the mast is near fully nested (final section approximately halfway retracted), remove the pin attaching the positive retraction reel to the strap winch. This will prevent the positive retraction cable from binding as the mast is fully nested. The positive retraction reel can remain on the winch at this time.

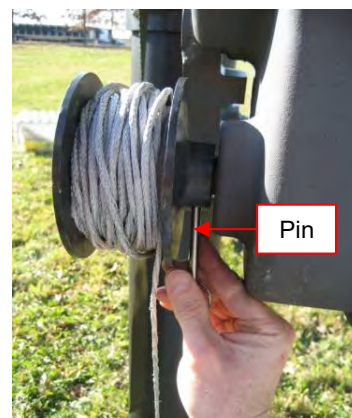


*Figure 5-2 Remove the Pin Attaching the Positive Retraction Reel to the Strap Winch*

5. Continue cranking the mast in the retraction direction until there is slack in the strap. Remove the pin from the square winch shaft. Then remove the strap reel from the square winch shaft (Figure 5-3).
6. Remove the positive retraction reel from the strap winch at this time and place it on the ground near the base of the mast (Figure 5-4).



*Figure 5-3 Remove Pin from the Square Winch Shaft*



*Figure 5-4 Remove the Positive Retraction Reel from the Strap Winch*

- Remove the pin connecting the strap winch to the strap winch bracket, tilt the strap winch upward to clear the winch bracket, and remove the strap winch from the winch post of the mast (Figure 5-5 and Figure 5-6). Note: This is a 2-person lifting operation.

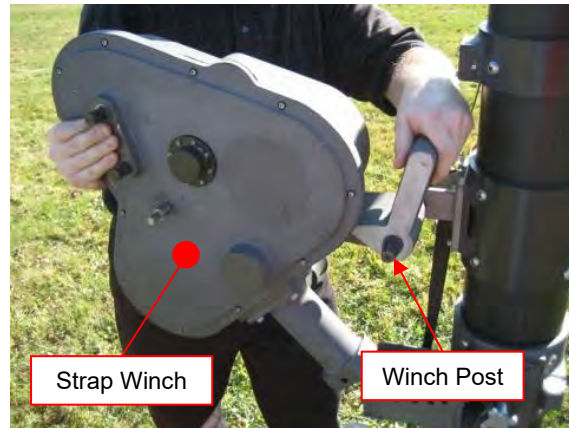
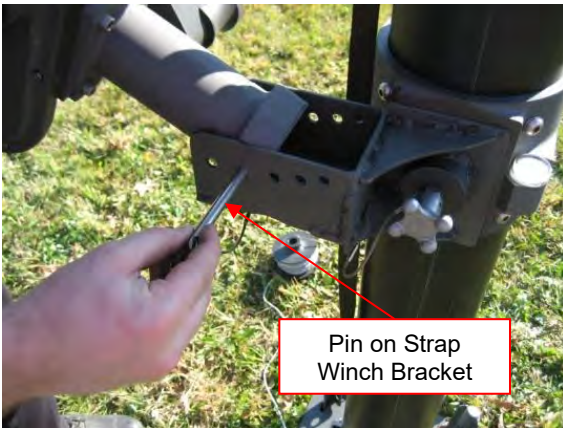


Figure 5-5 Remove Pin Connecting the Strap Winch to the Strap Winch Bracket

Figure 5-6 Remove Strap Winch from Winch Post of Mast

- Remove the strap winch bracket from the mast by first removing the hand knob that secures it to the mast. The strap winch bracket may need to be jostled to remove it from the mast (Figure 5-7).
- Add the positive retraction strap on the now empty winch post for storage and pin into place (Figure 5-8).

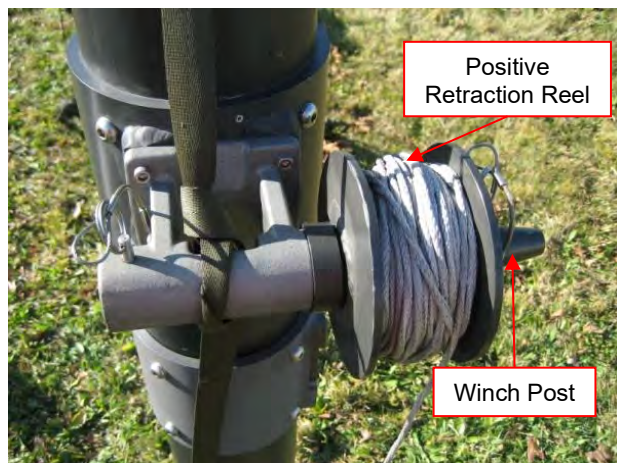
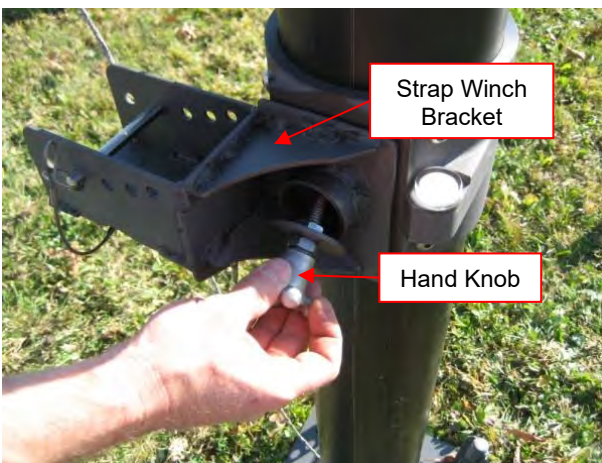


Figure 5-7 Remove Strap Winch Bracket

Figure 5-8 Add the Positive Retraction Strap and Pin in Place



Steps 10 through 11 explain how to retrieve the optional Gin Pole / Winch assembly.

If your installation did not require a Gin Pole / Winch assembly, please skip to Step 12.

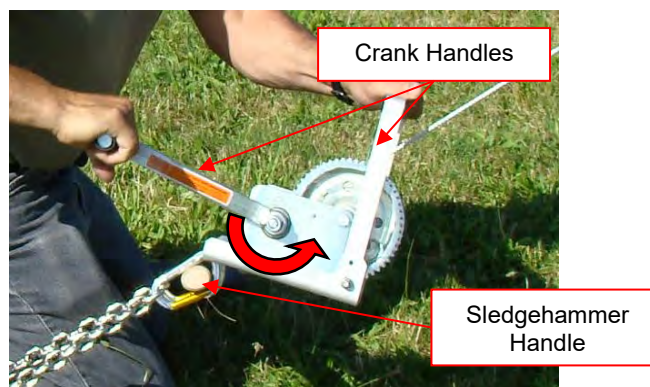
10. Confirm that the winch bracket is securely staked to the ground and the winch cable has less than 1 ft. (0.3 m) of slack. Position the gin pole in place, with its center 3 ft. (1 m) from the base of the mast.



*Figure 5-9 Position Gin Pole in Place with Its Center 3 Feet from Base of Mast*

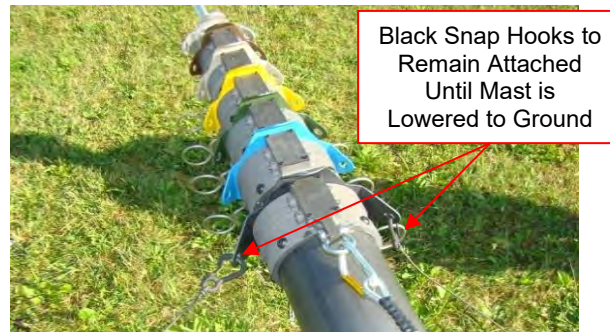
11. Release the one base guy line (black snap hook/black base plate) on the winch side of the mast and push the mast away from the winch to remove the slack in the cable. Loosen the side guy lines slightly. This will help the mast to pivot over freely.
12. Begin cranking the lift winch handle in a counterclockwise direction (when looking at the lift winch from the crank handle side). Confirm that the mast is gradually tilting over and that there is no slack in the cable. To better steady the lift winch during this operation:
  - a. Place your non-cranking hand on the carrying handle.
  - b. Slide the handle of the sledgehammer through the carabiners of the connecting chains and apply a slight downward force on this handle.

At all times during the winching operation, verify that the winch cable remains taut and in the center of the gin pole roller frame, that the mast remains in the "dish" portion of the base plate, that the guide rib of the mast remains in the slot of the base plate, and that the winch stakes are stable and do not move more than 3 in. (75 mm). Do not stand under the mast while it is being lowered (Figure 5-10).



*Figure 5-10 Crank Winch Counterclockwise*

13. If the side guy lines become tight, it may be necessary to loosen them further.
14. When the mast has reached a convenient working height, remove the payload, the rotator/tilter (if supplied), and all of the guy lines except the two side guy lines on the base tube (same guy lines that were installed first on the mast). Coil the rotator/tilter ropes (if supplied) for storage. Do not attempt to remove them from the rotator/tilter (Figure 5-11).



*Figure 5-11 Remove All Guy Lines Except Two on the Base Tube*

15. Lower the mast to the ground. Remove the remaining two black guy lines from the mast.
16. Unhook all of the guy tensioners from the guy stakes, wind them up on the guy line tensioners and place them in the transport bags.
17. Hit each guy stake on each edge (not on the inside or outside curved surfaces) then use the hammer to pry under the guy line hook rib (Figure 5-12).



*Figure 5-12 Hit Each Guy Stake on Each Edge and Use Hammer to Pry Under the Guy Line Hook Rib*

18. Stow all the accessories in the accessory bags. Refer to the accessory sheet for part identification and quantity verification.



### 5.3 Optional Stake Puller

This section explains how to remove the guy stakes using the optional stake puller. It can be used on different sizes of stakes including the 650mm and 850mm stakes.

To remove the stakes with the optional stake puller:

1. Connect the handle by pressing the blue button then inserting the pin.



Figure 5-13 Press Blue Button Then Insert the Pin to Connect Handle

2. There are three cutouts in the stake puller. Different cutouts are used for different types of stakes. Use the cutout that best fits your stake and the depth of your stake. Typically, the wider cutouts are used to pull stakes when they are all the way in the ground. The narrow cutout is used to remove stakes once the stake has been raised about a few inches out of the ground (Figure 5-14).
3. When the stake is driven all the way in the ground, place the wide or widest cutout over the stake (Figure 5-15).

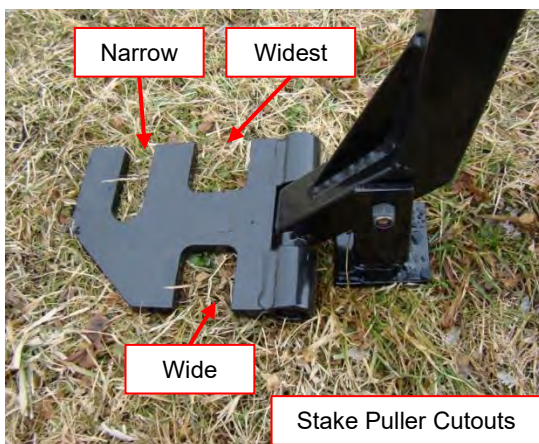
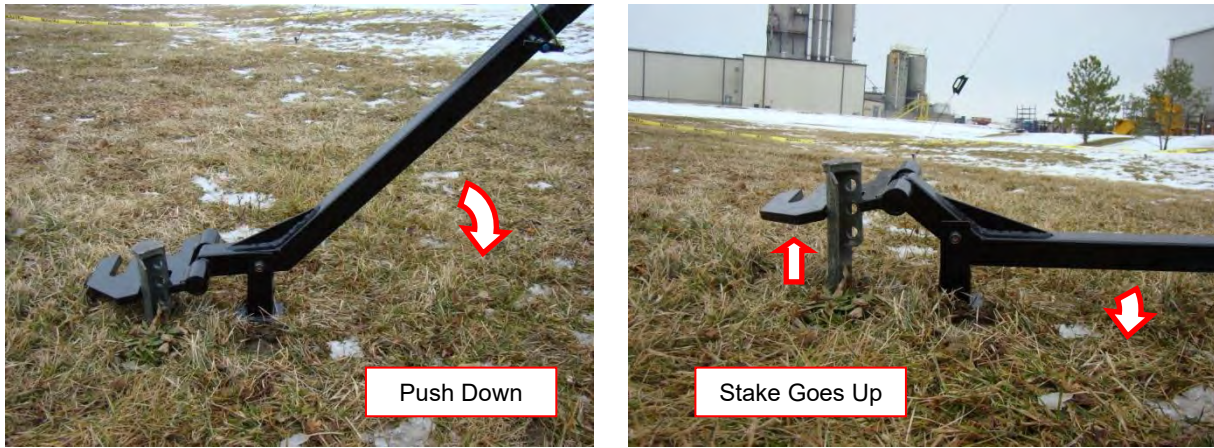


Figure 5-14 Use the Cutouts that Best Fit Your Stake

Figure 5-15 Place Wide or Widest Cutout Over the Stake

4. Push down on the stake puller handle. This will pull the stake a few inches out of the ground (Figure 5-16).



*Figure 5-16 Push Down on Stake Puller Handle*

5. Now that the stake is a few inches out of the ground, place the narrow cutout over the stake (Figure 5-17).



*Figure 5-17 Place Narrow Cutout Over the Stake*



6. Push down on the stake puller handle. This will pull the stake out a few more inches (Figure 5-18).

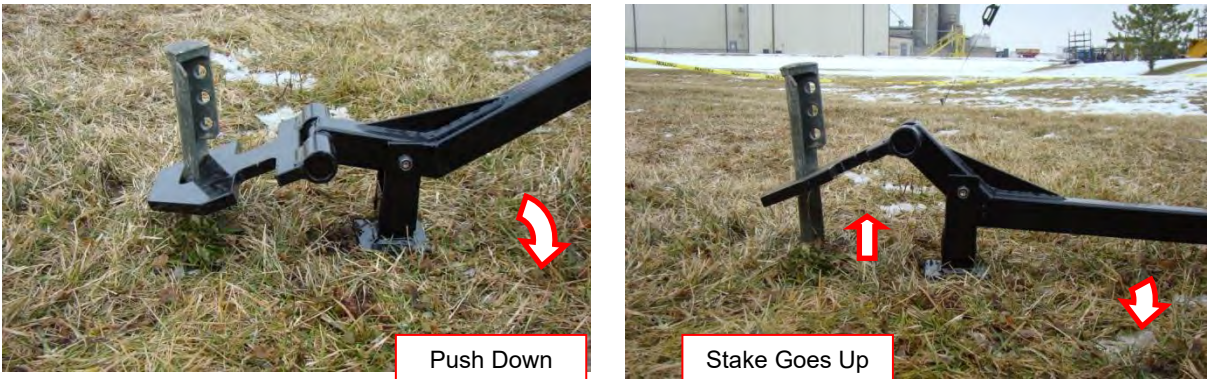


Figure 5-18 Push Down on Stake Puller Handle

7. Lift up on the stake puller handle and allow the cutout to rest back on the ground. Repeat step 6 and 7 until the stake is removed (Figure 5-19).



Figure 5-19 Lift Up on Handle

## Section 6 Transportation

Before transporting the mast system, the mast system needs to be secured. The exact procedures for transportation will vary based on the mast system configuration. The process described in this manual represents a possible method of transporting the mast. Depending on the environment and equipment available, other methods may work better. Use the best and safest method for your circumstances.

### 6.1 General Transportation

To prepare the mast system for transportation:

1. Ensure the mast is fully nested. Do not transport the mast system with the mast and payload extended. Always visually confirm the mast is fully retracted before moving the mast.
2. Ensure the components are fully and properly disassembled and placed into the appropriate accessory bags (Section 2.3).
3. Ensure the payload is removed, supported, or otherwise isolated from the top tube to prevent damage to the mast and payload.
4. Remove and secure the optional lift winch.
5. If necessary, secure any additional components in the mast system. Ensure mast strap is taut and secured.

Note: The operator should always visually confirm the mast is fully nested and properly stored before moving the vehicle for transport.

### 6.2 Shipping

When shipping the mast system, The Will-Burt Company recommends shipping the mast in the original shipping crate. If the original shipping crate is not available, contact The Will-Burt Company to order a replacement.

When shipping:

1. Prepare the mast system for transportation (Section 6.1).
2. Secure the mast system in the shipping crate:
  - a. Carefully position the mast in the crate.
  - b. Secure the block at the top of the mast to prevent the mast from shifting in the shipping crate during transportation.
  - c. Secure the top half of the wooden mast cradles.
  - d. As necessary, carefully pack any additional components in the shipping crate.
  - e. Secure the lid on the shipping crate.

(This page is intentionally left blank.)

## Section 7 Maintenance and Disposal

This section describes maintenance procedures required to keep the mast system operational. Use care to understand and follow all precautions while performing these procedures. If the system does not perform as required, contact The Will-Burt Company.

Disconnect power to any devices mounted to the mast with lock-out tagout procedures as appropriate before performing mast maintenance.

### 7.1 Pre-Maintenance Check

Before performing maintenance procedures, ensure:

- All operators read and understand the entire maintenance procedure and are properly trained.
- The system is level and secure.

### 7.2 Maintenance Equipment

Table 7-1 lists recommended equipment for maintenance.

Table 7-1 Equipment Recommended for Maintenance

Tools and Materials*			
<b>Personal Protective</b>			
Safety Glasses	Safety Gloves	Safety Shoes	Nitrile or Vinyl Gloves
Hard Hat or Helmet	Hearing Protection		
<b>Hand Tools</b>			
Hammer	Allen Wrenches	Wrenches	Measuring Tape
Level	Screwdrivers	Torque Wrench	Utility Knife
Strap Mast Tool Kit			
<b>Expendables</b>			
Acetone, Alcohol, or other solvent	Non-Abrasive Cleaners (Soap and Water)	Rags (Clean and Dry)	
* Note:			
<ul style="list-style-type: none"> <li>• Depending on the local, regional, and national standards and codes of practice, and the environment, additional personal protective equipment may be necessary.</li> <li>• When disposing of any disposables or components, do so according to any applicable local, regional, and national standards and codes of practice.</li> </ul>			

### 7.3 Spare Parts

To order spare or replacement parts, always refer to the mast model number and serial number. This information is included in the operator's manual supplied with each mast. The mast serial number is stamped at the bottom of the base tube. Model number, serial number and additional information is also engraved on the mast identification plate(s). The plate(s) are fixed to the base tube's collar.

### 7.4 Periodic Maintenance

This section describes the systematic care and inspection of equipment to keep it in safe operating condition and to prevent breakdowns. If the system does not perform as required or if anything looks wrong and cannot be diagnosed and/or fixed, contact The Will-Burt Company. Table 7-1 provides a schedule of periodic inspections and procedures required to keep the mast system in safe operating condition.

Perform the following checks in this section before and after each deployment. Do not attempt to deploy the mast if it does not pass all of the following checks.

Note: The mast strap winch is fully sealed and lifetime lubricated. It is not necessary to lubricate the strap winch.

Figure 7-1 Periodic Inspections

Frequency	Inspection	Action
As Needed; In salt water or sandy environments clean the mast every 3 months.	Inspect to ensure the mast system is kept clean and free from foreign material. Dirt, grease, oil, sand and debris may cover up a serious problem.	Wipe down all parts using a non-abrasive cleaner or non-acid solvent and a cloth. Do not use oil or grease on the mast because they will attract dirt and lead to high operating forces and premature wear.
During Operation	Inspect for damage during operation.	If damage is apparent, do not use the mast, and have it serviced prior to use.
Monthly	Inspect all hardware to ensure nuts, bolts, and other fasteners are not damaged, loosening, backing out or missing. Take special note of hardware keeping the payload mounted and hardware used to mount the mast to the support structure.	Tighten or replace any loose, damaged or missing nuts, bolts, and other fasteners.
Monthly	Inspect all clamps to ensure clamps are not damaged, cracked, have uneven wear or are missing.	Replace any cracked, unevenly worn, damaged or missing clamps.

Monthly	Inspect the Gin Pole for uneven wear and cracks in the tubes.	Replace unevenly worn-out component. Contact The Will-Burt Company.
As every use. It is highly recommended that guy tensioners be replaced every 5 years, regardless of usage.	Inspect guy lines for frayed, damaged or cut lines.	Stop use and replace frayed, damaged, or cut guy lines.
As every use	Verify that the bubble level is attached to the mast and is operational.	If missing or not operational, replace component. Contact The Will-Burt Company.
As every use	Visually inspect the crank handles for damage.	Replace damaged components.
As every use	Visually inspect the guy plates for cracks or elongated holes.	Replace damaged components.
As every use	Visually inspect the guy stakes for cracks or severe damage.	Replace cracked or severely damaged guy stakes.
As every use	Visually inspect the exterior of the mast for dents or other damage.	If damage is apparent, do not use the mast system and have it serviced before use.
As every use	Visually inspect the strap winch and the optional lift winch for damage.	Stop use and replace damaged components. Contact The Will-Burt Company.
As every use	Visually inspect the lift winch cable for fraying or other damage.	Stop use and replace frayed, damaged, or cut cable.
As every use	Verify that the strap winch automatic lock is operational while deploying the first section of the mast by letting go of the crank handles.	If not operational, stop use and contact The Will-Burt Company for service.
Inspect for cleanliness: As every use  Lubricate: 25 Cycles or as required	Inspect the lift winch cable and gearing to ensure it is clean.  Check if lubrication is needed.	Keep the lift winch cable and gearing clean.  Periodically lubricate the lift winch with silicone spray or light machine oil.


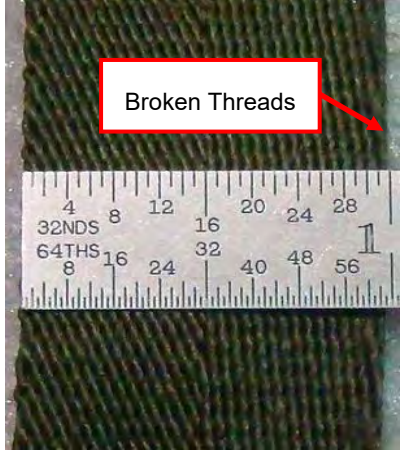
## 7.5 Strap Replacement Procedure

This section describes the strap visual inspection criteria and the strap replacement procedure. Use care to understand and follow all precautions while performing these procedures. If the system does not perform as required, contact The Will-Burt Company.

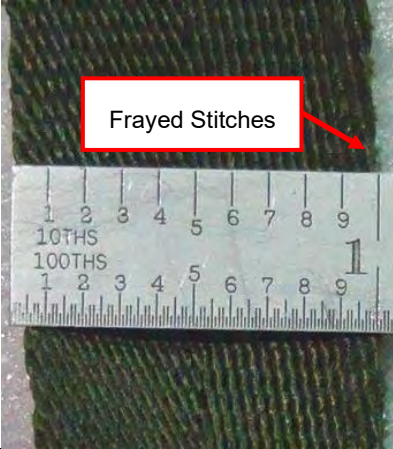
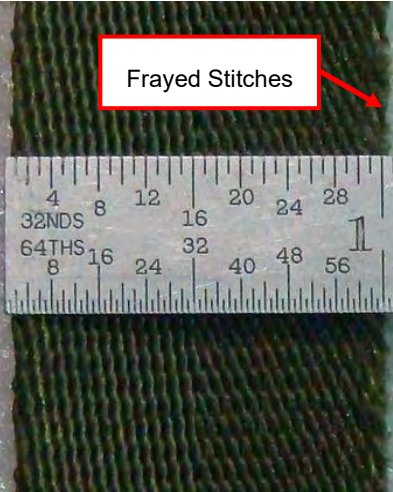
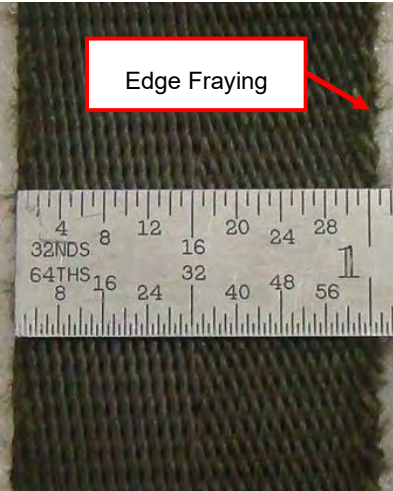
### 7.5.1 Strap Visual Inspection Criteria

Visually inspect the mast strap as the mast is deployed and retracted. If the strap is excessively frayed at any point along its length, do not deploy the mast. Refer to Table 7-2 to determine the fraying level of the strap.


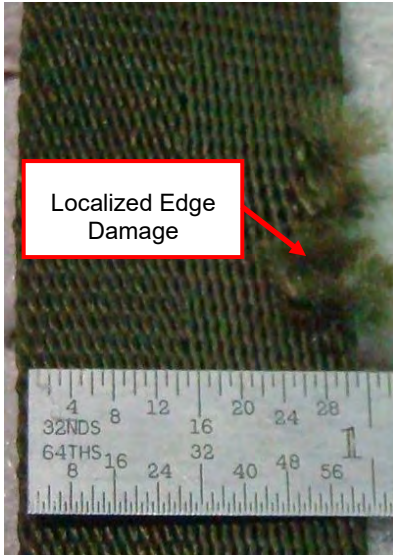

Table 7-2 Fraying Level of the Strap

Fraying Description and Level	Example Images
<p><b>New strap:</b></p> <ul style="list-style-type: none"> <li>• No fraying</li> <li>• Urethane coating evident (strap is stiff and shiny)</li> </ul>	
<p><b>Light-normal strap wear:</b></p> <ul style="list-style-type: none"> <li>• Slight fraying evident (on right side in this picture)</li> <li>• Edge stitches still intact</li> <li>• Strap still holds its shape well</li> <li>• Strap is okay for continued use</li> </ul>	



<p><b>Light-normal strap wear:</b></p> <ul style="list-style-type: none"> <li>• Slight fraying evident</li> <li>• Edge stitches wearing but still intact</li> <li>• Strap still holds its shape well</li> <li>• Strap is okay for continued use</li> </ul>	
<p><b>Medium-normal strap wear:</b></p> <ul style="list-style-type: none"> <li>• Edge stitches have more broken strands on right side in this picture</li> <li>• Strap still holds its shape</li> <li>• Strap is okay for continued use</li> </ul>	
<p><b>Medium-normal strap wear:</b></p> <ul style="list-style-type: none"> <li>• Edge is noticeably different on right side in this picture</li> <li>• Strap is okay for continued use but should be replaced within the next year, within the next 100 deployments, or if its condition worsens noticeably</li> </ul>	

<p><b>Medium-normal strap wear:</b></p> <ul style="list-style-type: none"> <li>• Edge stitches are still visible but are less defined</li> <li>• Strap is okay for continued use but should be replaced within the next year, within the next 100 deployments, or if its condition worsens noticeably</li> </ul>	
<p><b>Medium-heavy wear:</b></p> <ul style="list-style-type: none"> <li>• Right edge is frayed significantly</li> <li>• Edge stitches are difficult to distinguish</li> <li>• Strap is becoming “limp”</li> <li>• Strap must be replaced within the next 2 months or 25 mast deployments</li> </ul>	
<p><b>Medium-heavy wear:</b></p> <ul style="list-style-type: none"> <li>• Right edge is frayed significantly</li> <li>• Edge stitches are difficult to distinguish</li> <li>• Strap is becoming “limp”</li> <li>• Strap must be replaced within the next month or 10 mast deployments</li> </ul>	

<p><b>Heavy wear:</b></p> <ul style="list-style-type: none"> <li>• Right edge stitch is no longer present along the strap length</li> <li>• Heavy fraying presents danger of strap fibers becoming tangled within mast</li> <li>• Strap must be replaced before next mast deployment</li> </ul>	
<p><b>Localized cut or pinch damage:</b></p> <ul style="list-style-type: none"> <li>• Strap must be replaced before next mast deployment</li> </ul>	
<p><b>Localized pinch damage:</b></p> <ul style="list-style-type: none"> <li>• Strap must be replaced before next mast deployment</li> </ul>	



<p><b>Result of continued use of a strap with heavy wear or localized damage:</b></p> <ul style="list-style-type: none"> <li>• Longitudinal fibers became entangled in strap rollers – new strap could not be “pulled through” the mast</li> <li>• A complete mast teardown is required</li> </ul>	
--	--

### 7.5.2 Replace the Strap

To replace the strap:

1. The new strap will be joined to the free end of the old strap near the winch attachment point (Figure 7-2). If necessary, cut the old strap to provide a clean, square edge.
2. Using the string and needle provided in the Strap Mast Tool Kit, create a butt splice between the old and new strap with standard loop stitches (Figure 7-3).
3. Test the splice by pulling on the two straps. Watch for loose stitches or stitches pulling through the edges of the strap (Figure 7-4).



*Figure 7-2 New Strap will be Joined to Old Strap*



*Figure 7-3 Create a Butt Splice*



*Figure 7-4 Test the Splice*

4. Remove all of the pulley covers on the collars by removing the (4) screws (Figure 7-5).
5. It is critical that the new strap is fed into the mast without twisting or folding, one person must control the new strap as it feeds into the mast and maintain a light tension on it (Figure 7-6).

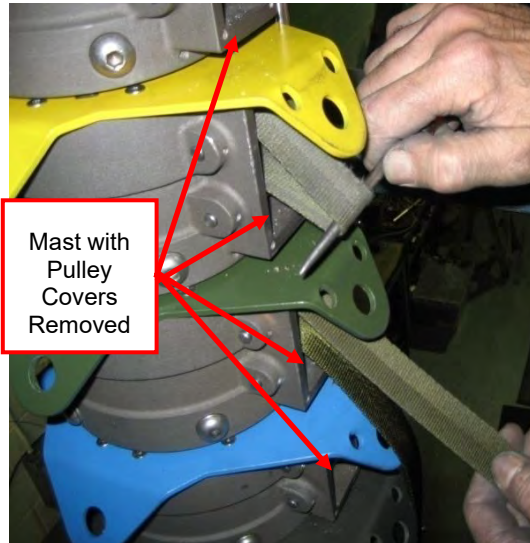


Figure 7-5 Remove Pulley Covers

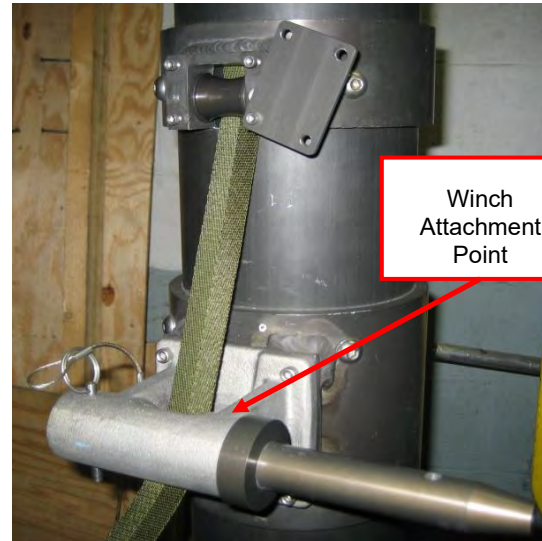


Figure 7-6 Feed New Strap Without Twisting or Folding

6. At the same time, the second person moves to the largest collar (nearest the winch attachment point) and begins pulling a loop of the strap out of the collar. It may be necessary to gently pry it out with a screwdriver or Allen wrench to start a loop. Once the loop can be grasped, begin pulling it such that the new strap feeds into the mast (Figure 7-7).

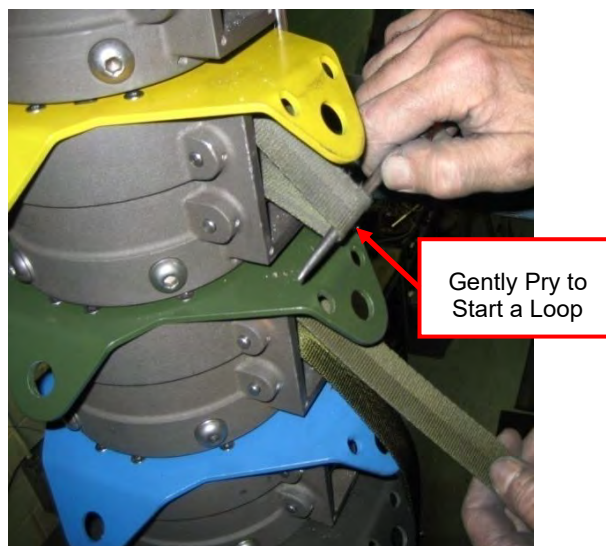


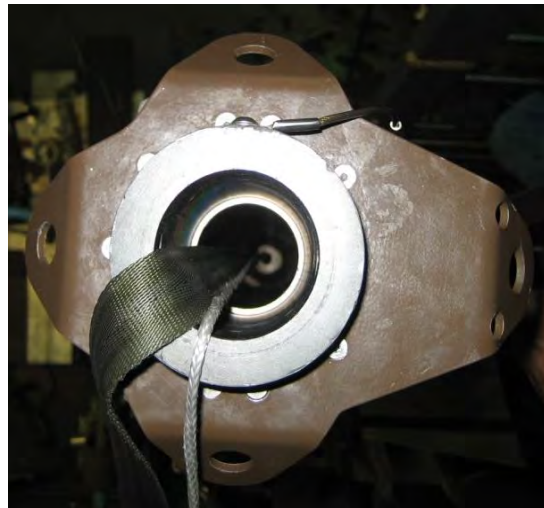
Figure 7-7 Pull Loop of the Strap Out of the Largest Collar



7. Pull a loop approximately 6 ft (2 m) long out of the collar and check to make sure that it is not twisted or folded.
8. Move to the next largest collar and repeat the procedure, watching the previous loop for twists or folds as it feeds into the mast. It is helpful to leave a small loop of strap outside the previous collar because this process will be repeated multiple times as the entire new strap is pulled into the mast.
9. Repeat this procedure to the top of the mast.
10. Confirm that the pull-down rope has approximately 3 ft (1m) of slack.
11. Using long needle-nose pliers, a long screwdriver or other device reach into the top of the mast and pull out the top stub cap. It is not attached to the top of the mast and should pull out freely if there is slack in the strap and pull-down rope and if it is pulled straight out. If it jams, try pushing it back in to square it up and then pull it straight out (Figure 7-8).
12. Once the top stub cap is out of the mast, note the strap routing through the top stub cap, around the strap pin and back through the top stub cap. Remove the two socket head cap screws holding the strap pin to the top stub cap, remove the strap pin and pull the strap out of the top stub cap.
13. Set the top stub cap (still attached to the pull-down rope) to the side of the mast and begin pulling the strap out the top of the mast (Figure 7-9).



*Figure 7-8 Pull Out the Top Stub Cap*



*Figure 7-9 Pull Strap Out of the Top of the Mast*

14. Move back to the largest collar and repeat the process until the butt splice is pulled out the top of the mast. Always leaving a small loop of strap at each collar.
15. Cut the butt splice and discard the old strap.
16. Fold about 6 in (15 cm) of the new strap over at the top of the mast and push the fold through the lower side of the top stub cap (the side opposite the knot in the rope) just enough to allow the strap pin to pass through the resulting loop.

17. Insert the strap pin through the strap, grasp both sides of the strap and pull the loop tight on the strap pin.
18. Secure the strap pin in place with the two socket head cap screws (Figure 7-10).



*Figure 7-10 Secure Strap Pin in Place*

19. Insert the top stub cap back into the top of the mast and pull it into place by pulling the loop of strap at the nearest collar.
20. Working from the top of the mast down, pull the strap tight at each collar and at the bottom of the mast near the winch attachment point.
21. Wind the pull-down rope tight on the drum and secure the drum in its stowed position.

## 7.6 Long-Term Storage

When putting the system into long-term storage, ensure the:

- Mast is fully nested.
- Payload is removed.
- Mast system is clean. Dirt, grease, oil, and debris only serve to collect additional dirt during storage. Use denatured alcohol on all metal surfaces. Use water when cleaning rubber or plastic material. Use soap and water when cleaning the exterior surfaces of the mast tubes.
- Mast is placed into appropriate shipping crate. If necessary, replacement shipping crates may be ordered.
- Components are fully disassembled and are placed into the appropriate bags and crate.
- Mast and components are stored in a clean and dry environment.

---

## 7.7 System Disposal

Dispose of the mast in accordance with the national environmental regulations.

## Section 8 Mast Recovery Procedures

This section describes recovery procedures for the mast system. Use care to understand and follow all precautions while recovering the mast system.

**⚠ WARNING**

**Impact and Pinch Point Hazard!** When a mast is not functioning per standard operating procedures, it is often an indication of damage. Use extreme caution at all times when attempting these recovery procedures because the mast may move suddenly and forcefully at any time. Serious injury or death can occur if personnel is in the area of motion.

### 8.1 Removing the Winch from an Extended Mast - Winch Issues

To remove the winch from an extended mast:

1. Tightly clamp the aluminum clamp block in place over the strap near the mast using the provided locking pliers (Figure 8-1).
2. Carefully crank the winch in the reverse direction (“LOWER”) to transfer the load from the winch to the clamp block. Transfer of the load is accomplished when the strap between the winch and the aluminum clamp block hangs freely (Figure 8-2).

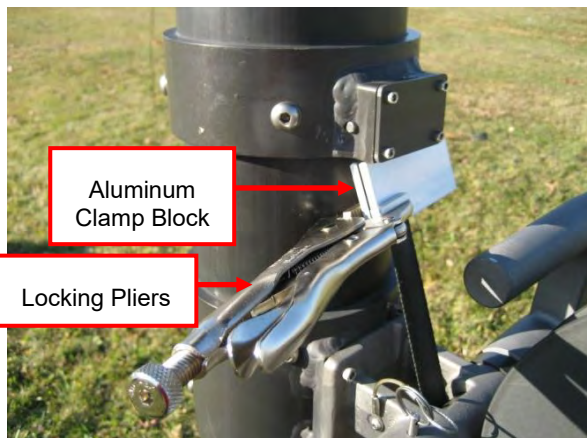


Figure 8-1 Clamp Aluminum Clamp Block Over Strap



Figure 8-2 Crank Winch in Reverse Direction

3. Once the load has been fully transferred to the clamp block, the winch can be removed from the mast per the normal "Mast Retrieval" procedures in this manual (Figure 8-3).



*Figure 8-3 Once Load has Been Fully Transferred to the Clamp Block, Winch can be Removed*

4. Repair or replace the winch as soon as possible. The clamp block is not intended to support the mast for extended periods.

## 8.2 Mast Jammed in Extended Position

If the mast is jammed in the extended position, perform the following procedures to unjam the mast.

### 8.2.1 Standard Procedures

If the mast is jammed in the extended position:

1. Visually check for obstructions (guy lines, positioner ropes, cabling, etc.) that may be keeping the uppermost tube from nesting. Extend the mast and remove the obstruction as required.
2. Try raising and lowering the mast several times at various speeds (slow and fast). Sometimes a minor internal jam can be cleared with this process.
3. Confirm recent weather conditions. If icing is a possible cause for the jam, is it possible to wait for the mast to thaw? Alternately, the positive retraction base roller cover can be removed and warm air (must be less than 150° F (65° C)) can be blown into the base of the mast.
4. Lower the mast to the point of the jam and pull on the upper guy lines gently from side to side, then straight down with a gradually increasing load up to 100 lb. (445 N) total. Alternate these two loads several times as required.
5. If the previous steps did not work, pull straight down on the upper guy lines with quick, short movements, being careful not to apply more than 100 lb. of force (445 N).
6. If the mast is still jammed in an extended position, proceed to Emergency Procedure I (Section 8.2.2).



## 8.2.2 Emergency Procedure I

This section describes procedures to follow if the mast is jammed in an extended position and the Standard Procedures (Section 8.2.1) did not correct the issue.

Take heed of the following precautions:

**⚠ WARNING**

**Mast Retraction Hazard!** The following procedure may damage the mast and can cause serious injury if not performed carefully. Use these methods only when absolutely necessary.

**⚠ WARNING**

**Impact Hazard!** Note that the mast may drop very rapidly until all of the slack in the strap is taken up. This procedure can be dangerous and can cause high impact loads to the mast and winch. Use it only when absolutely necessary and always inspect the mast and winch thoroughly afterward for bent or broken components.

If the mast is jammed in the extended position:

1. Raise the mast approximately 1.5 ft (0.5 m) above the point of the jam with the strap winch.
2. Place the aluminum clamp block in place per the winch removal procedure (Figure 8-3).
3. Carefully crank the winch in the reverse direction (“LOWER”) to transfer the load from the winch to the clamp block. Transfer of the load is accomplished when the strap between the winch and the aluminum clamp block hangs freely (Figure 8-4).



*Figure 8-4 Crank Winch in Reverse Direction to Transfer Load from Winch to Clamp Block*

4. Continue cranking in the reverse direction until approximately 3 ft (1 m) of “slack” is hanging between the winch drum and the clamp block.
5. Release the locking pliers from the clamping block quickly and carefully from a position at the side of the mast.

6. This procedure can be repeated more than once if necessary. Never allow more than 3 ft (1 m) of slack in the strap as this may lead to twists in the strap feeding into the mast and/or high impact loads breaking the loaded components of the winch.
7. If the mast is still jammed in an extended position, proceed to Emergency Procedure II (Section 8.2.3).

### 8.2.3 Emergency Procedure II

This section describes procedures to follow if the mast is jammed in an extended position and the Standard Procedures (Section 8.2.1) and Emergency Procedure I (Section 8.2.2) did not correct the issue.

Take heed of the following precautions:

**⚠ WARNING**

**Mast Retraction Hazard!** The following procedure may damage the mast and can cause serious injury if not performed carefully. Use these methods only when absolutely necessary. Do not attempt to perform this procedure in winds exceeding 10 mph (16 km/hr). Do not attempt to perform this procedure without a crew chief or commanding officer and 9 support personnel present.

**⚠ WARNING**

**Falling Mast Hazard!** In this procedure, the lowest moving section of the mast will be released and lowered. This procedure can be extremely dangerous because it lowers the entire mast and releases the tension in all of the guy lines simultaneously. The mast will fall over if the base tube guy lines are not sufficiently held in tension. The mast may also fall over if the guy lines are pulled excessively in any one direction.

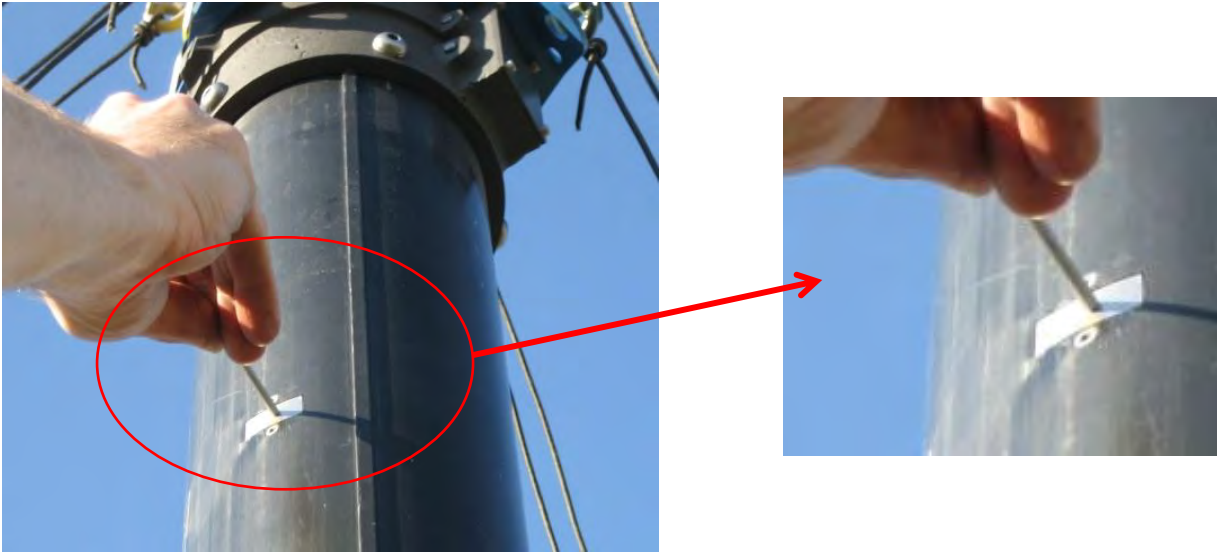
If the mast is jammed in the extended position:

1. Extend the mast per normal deployment procedures until the top section is within 1.5 ft (0.5 m) of full extension. This will minimize the distance that the 5.5" tube (the tube directly above the base tube) will free-fall when it is released.
2. Deploy personnel to the outer two guy lines in each of the four guying directions (8 people total).
3. Deploy one person to the base of the mast to operate the winch and continuously sight the mast for vertical after it has been released.
4. The crew chief or commanding officer should take a central position near the mast to help sight the mast and give orders to the personnel at the guy lines to keep the mast as vertical as possible.
5. Use a ladder or scaffold to perform the remainder of the steps. Latch plates are located near the top of the base tube.

**⚠ WARNING**

**Impact and Pinch Point Hazard!** In the next step, the 5.5" section of the mast may drop partially or completely at a very high speed. Keep hands, arms and body away from the mast as much as possible when releasing the latches.

6. With the outer two guy lines pulled snug at each location by the (8) outer personnel, the person at the base of the mast should put the 1/8" Allen wrench (included in the provided Strap Mast Tool Kit) into each access hole and with a quick, open-palmed impact to the handle, release each of the four latches (Figure 8-5).



*Figure 8-5 Put 1/8" Allen Wrench into Each Access Hold and Release Each of the Four Latches*

7. Once the 5.5" section has been released, the person at the base of the mast can crank the winch in the "LOWER" direction. The 5.5" section will normally lower completely and then the uppermost extended section of the mast will begin to lower.
8. If necessary, before completely lowering the 5.5" section, the 5.0" section (the next section above the 5.5") can be released by following this same procedure starting at Step #5.

(This page is intentionally left blank.)