

RECOVERY AND WORK TRUCK LIGHTING SOLUTIONS



Watch
Product Video



Visit
Corporate Website



Download
Product Brochure



Watch
Corporate Video

Will-Burt is the world's leading manufacturer of light towers. A line of fully integrated mobile lighting towers, the Night Scan® HDT Series, has been designed specifically for the towing, recovery and service truck industry.

The Night Scan® HDT Series has been engineered and manufactured in the USA for the harsh environments and extreme conditions experienced by the your industry. Field proven across the country and around the world, the Night Scan® HDT is ready to become an important tool in your arsenal of equipment, improving the safety and efficiency of operations by turning night into day.



THE ADVANTAGE OF THE NIGHT SCAN® HDT SERIES

- Safety of nighttime recovery operations is enhanced with 360° of overhead light...turning night into day!
- Speed of safe recovery operations is increased with lighting that is in place and on in 15 seconds
- Years of service with maintenance-free design
- Fast Return on Investment
 - Increase your Revenue
 - Average charge per hour = \$250
- Record recovery scene events
 - Proof for insurance
 - Accurate billing
- Eliminates the need for a lighting trailer - light is always with the wrecker
- No generator required and self-contained system
- Retrofit to existing vehicle or install on a new build with small footprint
- Easy and fast operation with automatic deployment and stowing
- LED lights with a limited lifetime warranty Night Scan X200, XL200 and Sirion

CONTENTS



**HEAVY WRECKERS /
LARGE TRUCKS**
NIGHT SCAN®
POWERLITE HDT..... 4-5



**ROLLBACKS, TOW
& UTILITY TRUCKS**
NIGHT SCAN® CHIEF
PROFILER HDT.....12



**HEAVY WRECKERS /
LARGE TRUCKS**
NIGHT SCAN® POWERLITE
VERTICAL HDT 6-7

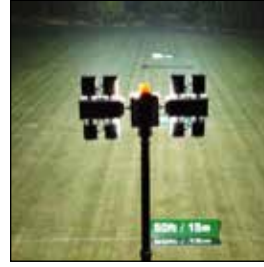

**NIGHT SCAN®
LED LAMPS..... 13**



**HEAVY WRECKERS /
LARGE TRUCKS**
NIGHT SCAN® POWERLITE
PROFILER HDT..... 8-9



**NIGHT SCAN HDT
SCENE LIGHTING 14**



**ROLLBACKS, TOW
& UTILITY TRUCKS**
NIGHT SCAN® CHIEF HDT &
CHIEF VERTICAL HDT..... 10-11



**NIGHT SCAN HDT
UNITE MODULAR
LED LIGHT BAR 15**



HEAVY WRECKERS & LARGE TRUCKS

**NIGHT SCAN®
POWERLITE HDT**

ESSENTIAL FEATURES

- Improves nighttime safety and efficiency
- Increases Revenue
- No generator required, works from vehicle power
- Generates up to 220,000 lumens with optional Sirion LED light package featuring triple coverage optics
- Full independent rotation and tilt of both banks of lights - 360° of light
- Rapid recovery scene illumination in 15 seconds with the touch of one button
- Includes everything needed for installation
- For new installs or retrofit
- Optional wireless remote
- Optional video and recording

SPECIFICATIONS

Powerlite HDT	WB 300	XL 200	Sirion
Height Extended	15 ft.		
Total Lumens	90,000	120,000	220,000
Weight	175 lbs.		
Footprint of Stowed System	75¼" L x 43⅜" W x 12" H		
Tower Warranty	2 Years		
Light Warranty	2 Years	Limited Lifetime	
Color Option	Standard color white. Black option for additional charge.		



HEAVY WRECKERS & LARGE TRUCKS



INSTALLATION DIMENSIONS

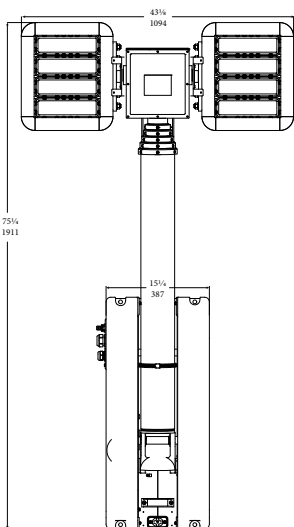

WB 300
720030054

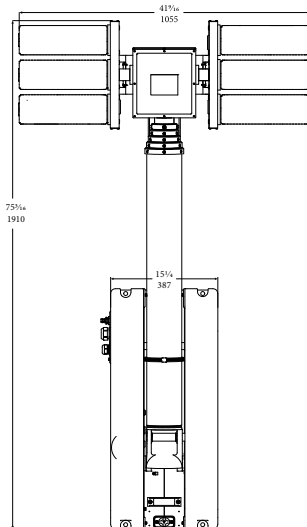

Night Scan XL 200
720030025

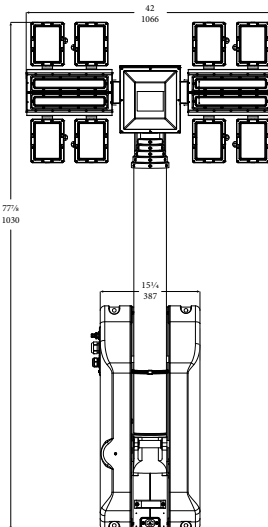

Sirion
720030034



Included
Handheld Wired
Controller

Optional
Universal Wireless
Controller

Optional LED Beacon Lights
(Amber, Blue, Clear, Red or Green)

HEAVY WRECKERS & LARGE TRUCKS

NIGHT SCAN® POWERLITE VERTICAL HDT

ESSENTIAL FEATURES

- Improves nighttime safety and efficiency
- Increases Revenue
- No generator required, works from vehicle power
- Needs only 12" for installation
- Generates up to 220,000 lumens with optional Sirion LED light package featuring triple coverage optics
- Full independent rotation and tilt of both banks of lights - 360° of light
- Rapid recovery scene illumination in 15 seconds with the touch of one button
- Includes everything needed for installation
- For new installs or retrofit
- Optional wireless remote
- Optional video and recording

SPECIFICATIONS

Powerlite Vertical HDT	WB 300	XL 200	Sirion
Height Extended	15 ft.		
Total Lumens	90,000	120,000	220,000
Weight	175 lbs.		
Footprint of Stowed System	70 $\frac{3}{8}$ " L x 43 $\frac{1}{8}$ " W x 12" D		
Tower Warranty	2 Years		
Light Warranty	2 Years	Limited Lifetime	
Color Option	Standard color white. Black option for additional charge.		



HEAVY WRECKERS & LARGE TRUCKS



INSTALLATION DIMENSIONS

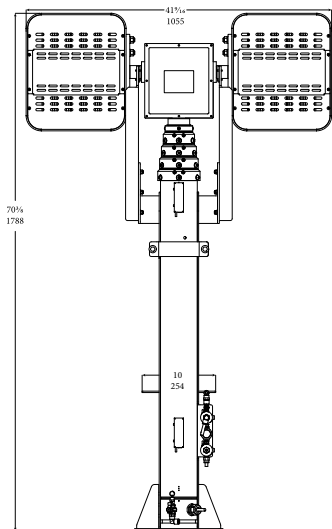

WB 300
720030054

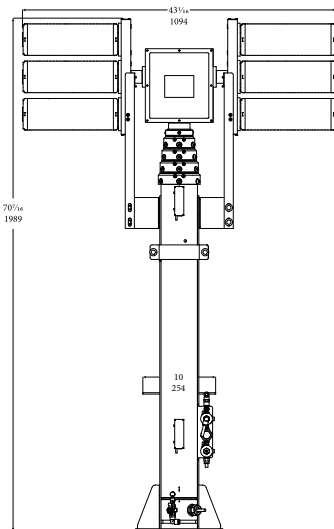

Night Scan XL 200
720030025

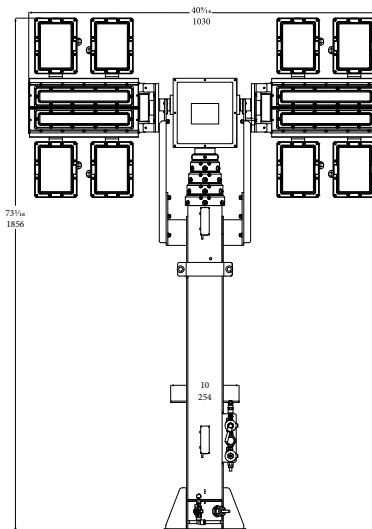

Sirion
720030034



HEAVY WRECKERS & LARGE TRUCKS

**NIGHT SCAN® POWERLITE
PROFILER HDT**

ESSENTIAL FEATURES

- Improves nighttime safety and efficiency
- Increases Revenue
- No generator required, works from vehicle power
- Narrow profile saves space
- Generates up to 110,000 lumens with optional Sirion LED light package featuring triple coverage optics
- Full rotation and tilt control of lights
- Rapid recovery scene illumination in 15 seconds with the touch of one button
- Includes everything needed for installation
- For new installs or retrofit
- Optional wireless remote

SPECIFICATIONS

Powerlite Profiler HDT	XL 200	Sirion
Height Extended	12 ft.	
Total Lumens	60,000	110,000
Weight	165 lbs.	
Footprint of Stowed System	78 ⁷ / ₈ " L x 20 ¹ / ₄ " W x 13 ¹ / ₄ " D	
Tower Warranty	2 Years	
Light Warranty	Limited Lifetime	
Color Option	Standard color white. Black option for additional charge.	



HEAVY WRECKERS & LARGE TRUCKS



INSTALLATION DIMENSIONS

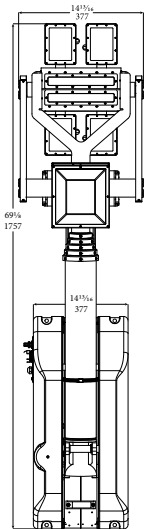

Sirion
721088015

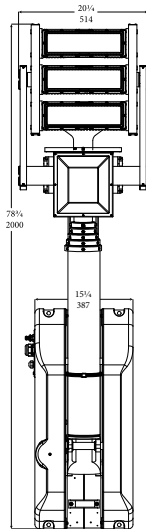

Night Scan XL 200
721560057



Included
Handheld Wired
Controller



Optional
Universal Wireless
Controller

ROLLBACKS, TOW & UTILITY TRUCKS

NIGHT SCAN® CHIEF HDT

ESSENTIAL FEATURES

- Improves nighttime safety and efficiency
- Increase Revenue
- No generator required, works from vehicle power
- Built-in compressor – no truck air needed
- Generates up to 80,000 lumens with Night Scan X 200 Spot and Flood LED lights
- Full rotation and tilt of both lights
- Rapid recovery scene illumination
- Includes everything needed for installation
- For new installs or retrofit
- Optional wireless remote
- Optional video and recording

SPECIFICATIONS

Chief HDT	WB 140	X 200
Height Extended	7.5 ft.	
Total Lumens	28,000	80,000
Weight	95 lbs.	122 lbs.
Footprint of Stowed System	51 ¹³ / ₁₆ " L x 28 ¹ / ₄ " W x 9 ³ / ₈ " D	53 ¹ / ₄ " L x 27 ¹ / ₂ " W x 9 ³ / ₈ " D
Tower Warranty	2 Years	
Light Warranty	5 Years	Limited Lifetime



INSTALLATION DIMENSIONS

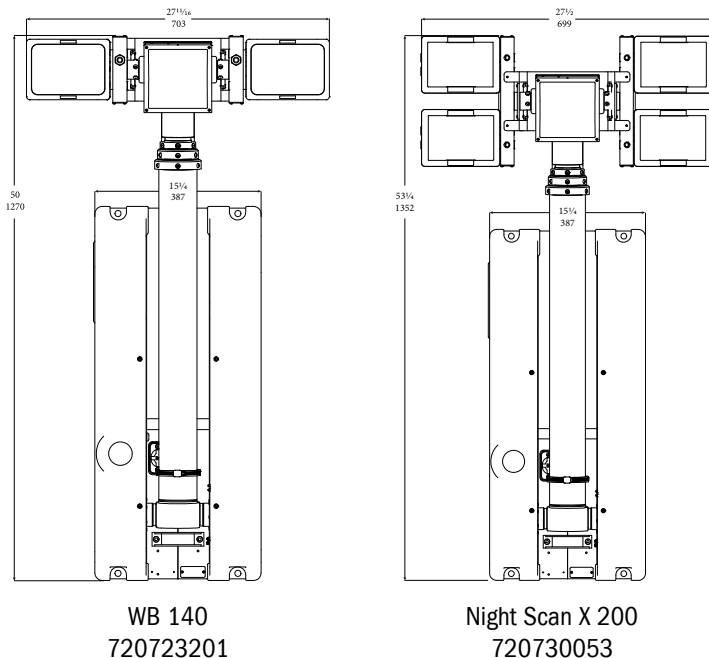

ROLLBACKS, TOW & UTILITY TRUCKS

NIGHT SCAN® CHIEF VERTICAL HDT

ESSENTIAL FEATURES

- Improves nighttime safety and efficiency
- Increases Revenue
- No generator required, works from vehicle power
- Narrow profile saves space
- Generates up to 80,000 lumens with Night Scan X 200 Spot and Flood LED lights
- Full rotation and tilt control of lights
- Rapid recovery scene illumination in 15 seconds with the touch of one button
- Includes everything needed for installation
- For new installs or retrofit
- Optional wireless remote

SPECIFICATIONS

Chief Vertical HDT	WB 140	X 200
Height Extended	7.5 ft.	
Total Lumens	28,000	80,000
Weight	95 lbs.	122 lbs.
Footprint of Stowed System	51 ¹³ / ₁₆ " L x 28 ¹ / ₄ " W x 9 ³ / ₈ " D	53 ¹ / ₄ " L x 27 ¹ / ₂ " W x 9 ³ / ₈ " D
Tower Warranty	2 Years	
Light Warranty	5 Years	Limited Lifetime



INSTALLATION DIMENSIONS

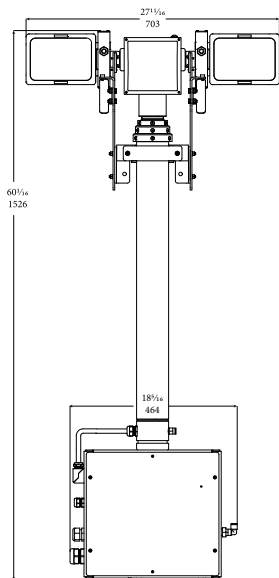

Night Scan WB 140
720088079

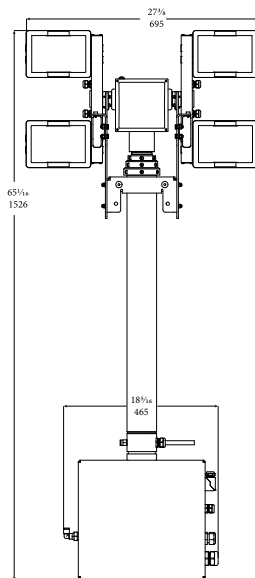

Night Scan X 200
720088085



ROLLBACKS, TOW & UTILITY TRUCKS

NIGHT SCAN® CHIEF PROFILER HDT

ESSENTIAL FEATURES

- Improves nighttime safety and efficiency
- Increases Revenue
- No generator required, works from vehicle power
- Narrow profile saves space
- Built-in compressor - no truck air needed
- Generates up to 60,000 lumens with Night Scan X 200 Spot and Flood LED lights
- Full rotation and tilt control of lights
- Rapid recovery scene illumination
- Includes everything needed for installation
- For new installs or retrofit
- Optional wireless remote

SPECIFICATIONS

Chief Profiler HDT	X 200
Height Extended	7.5 ft.
Total Lumens	60,000
Weight	122 lbs.
Footprint of Stowed System	53¼" L x 27½" W x 9¾" D
Tower Warranty	2 Years
Light Warranty	Limited Lifetime



INSTALLATION DIMENSIONS

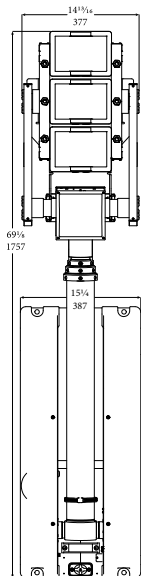

Night Scan X 200
720795051





NIGHT SCAN® LED LAMPS

Night Scan® X200, XL200 and Sirion LED lamps are the only LED scene lights designed specifically for Night Scan light towers. These lamps are engineered to optimize the inherent benefits of Night Scan towers, producing more light, using less power, and covering larger areas. Reliable in extreme environments, Night Scan LED lamps are IP69K rated for high-pressure spray and are submersible under water. Both lights carry a limited lifetime warranty.

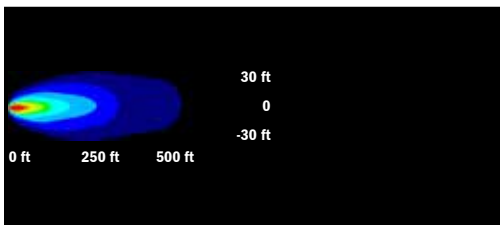

Model	X200	
Raw Lumens	20,000 each	
Effective Lumens	11,323 each	
Warranty	Limited Lifetime	
Optics	Double - Spot / Flood	



Model	XL200	
Raw Lumens	20,000 each	
Effective Lumens	11,362 each	
Warranty	Limited Lifetime	
Optics	Double - Spot / Flood	

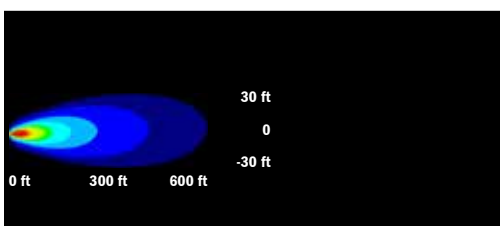

Model	Sirion	
Raw Lumens	110,000 each	
Effective Lumens	61,170 each	
Warranty	Limited Lifetime	
Optics	Triple - Spot / Short & Long Flood	

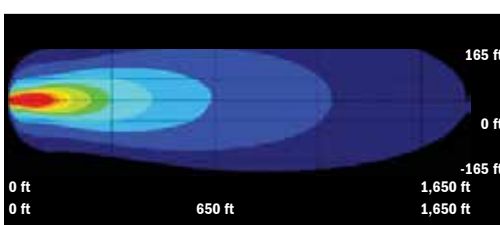

NIGHT SCAN HDT SCENE LIGHTING

The Night Scan line of rugged, Heavy-Duty Towing LED Lights are built for your world. The tough and compact, aluminum housing coupled with ultra-bright Cree LEDs makes it the perfect light for any application. From fog lights to roof rack, work light and reverse lighting, Night Scan's HDT LED lights combine usability with affordability to create the ultimate lighting solution. The HDT Series lights come standard with a single bolt mounting bracket, wiring harness, and 2-year warranty.







SPECIFICATIONS

Model	WB 140	HDT 60	HDT 40	HDT 40 Mini
LED	(27) 1.8W	(6) 5W CREE	(4) 5W CREE	(4) 3W CREE
Beam Pattern	60°	40°	40°	10°/25° Mixed Beam
Raw Lumens (lm)	14,000	3,686	2,112	2,000
Effective Lumens (lm)	8,350	2,590	1,480	950
Usable Light Distance at 1 Lux	328 ft. / 100m	381 ft. / 116m	262 ft. / 80m	295 ft. / 90m
Watts	50W	30W	20W	12W
Amp Draw @12V	4.2A	2.5A	1.67A	1A
Input Voltage	10-32V DC	11-65V DC	11-65V DC	11-65V DC
Size (W x H x D)	7.60" x 5.55" x 1.65"	5.38" x 4.19" x 2.72"	3.94" x 4.42" x 2.57"	2.75" x 3.62" x 1.94"
Weight	2.75 lb / 1.25 kg	2.63 lb / 1.2 kg	1.50 lb / .68 kg	.88 lb / 0.4 kg

ESSENTIAL FEATURES

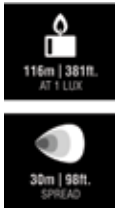
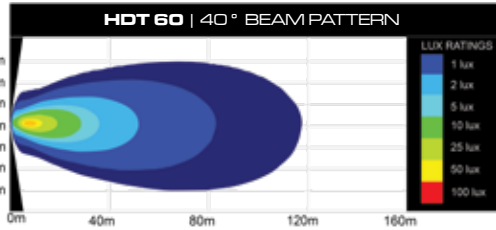
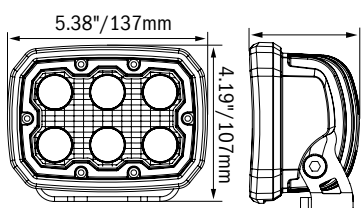
- Cast Aluminum Housings & Polycarbonate Lenses
- Extreme Output / Long-Life LEDs
- Water-proof (IP69K) Housing with Weather-proof Connectors
- Two-year Warranty
- Ultra Bright Cree LEDs
- Single Bolt Trunion Bracket

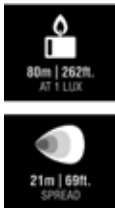
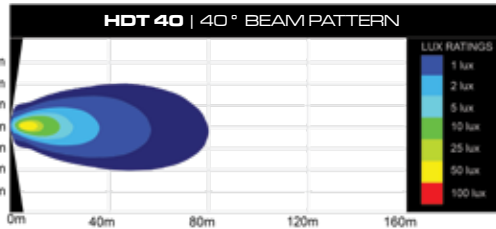
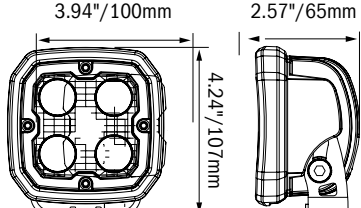
ENGINEERING SPECIFICATIONS

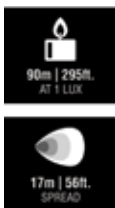
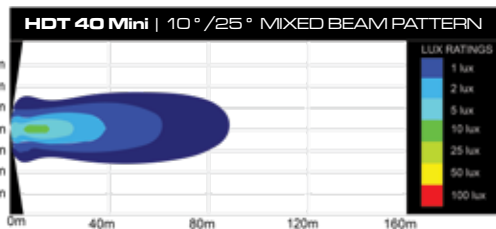
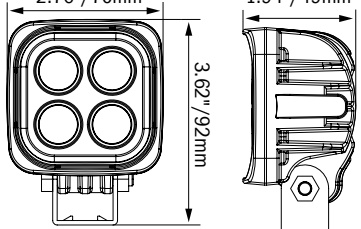
<p>HDT 60</p> 	 <p>116m 381ft. AT 1 LUX.</p> <p>30m 98ft. SPREAD</p>	<p>HDT 60 40° BEAM PATTERN</p> 	 <p>5.38"/137mm</p> <p>4.19"/107mm</p>
<p>HDT 40</p> 	 <p>80m 262ft. AT 1 LUX.</p> <p>21m 69ft. SPREAD</p>	<p>HDT 40 40° BEAM PATTERN</p> 	 <p>3.94"/100mm</p> <p>2.57"/65mm</p> <p>4.24"/107mm</p>
<p>HDT 40 Mini</p> 	 <p>90m 295ft. AT 1 LUX.</p> <p>17m 56ft. SPREAD</p>	<p>HDT 40 Mini 10°/25° MIXED BEAM PATTERN</p> 	 <p>2.76"/70mm</p> <p>1.94"/49mm</p> <p>3.62"/92mm</p>

NIGHT SCAN HDT UNITE MODULAR LED LIGHT BAR



The Night Scan HDT Unite Modular LED Light Bar System brings lighting power and customization to the forefront with extensive configuration possibilities. Choose a Length (12", 20", 30", 40" 50"), Straight or Curved Mounting Rail. Then choose any combination of 3" LED Modules White or Amber, Spot or Flood that each slide-on and connect with no tedious wiring.



ESSENTIAL FEATURES

- Endless Lighting Configurations
- Straight And Curved Bar Styles
- Amber and White LED Options
- Spot And Flood Beam Pattern Options
- Clear And Black-Out Faceplate Styles
- 6", 12", 20", 30", 40", 50" Lengths
- Adjustable Aiming End Cap Wing Mounts
- Quick Connect Rail System
- IP-68/69K Rated Housing

SPECIFICATIONS (PER MODEL)

		
Model	White LED	Amber LED
LED	5W CREE	3W CREE Amber
Raw Lumens	2,112lm	510lm
Watts	20W	12W
Amp Draw	1.67A	1A
Input Voltage	11-32V DC	
IP Rating	IP68/69K	
Dimensions	2.76" x 2.76" x 2.76"	
Beam Pattern	Broad Spot & Flood	
Length Options	6", 12", 20", 30", 40", 50"	
Warranty	Limited Lifetime	

UNITE MODULAR LED LIGHT BAR

BROAD
SPOT
BEAM



FLOOD
BEAM

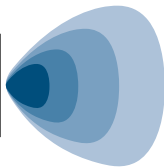

BEAM PATTERN



CUSTOMIZE MODULES

Choose between 8 different modules giving you complete control over your lighting.

QUICK CONNECT RAIL

Easily switch between modules to match your lighting style.

ADJUSTABLE AIMING

Slotted heavy duty wing mounts allow for precise lighting placement.

UNITE
LENGTH & STYLE
OPTIONS



STRAIGHT BAR
6" | 12" | 20" | 30" | 40" | 50"



CURVED BAR
20" | 30" | 40" | 50"

UNITE
MODULE STYLE
OPTIONS



**LED COLOR
OPTIONS**
Amber or White



**BEAM PATTERN
OPTIONS**
Flood or Spot



**FACEPLATE
OPTIONS**
Blackout or Clear

CONTACT YOUR SALES REPRESENTATIVE TODAY

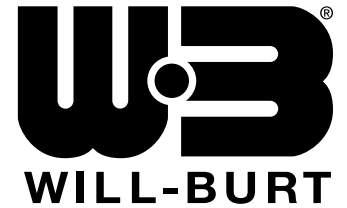

Contact Us
Complete a Contact Form

**WILL-BURT NORTH AMERICA
WORLD HEADQUARTERS**

401 Collins Boulevard, Orrville, OH USA 44667
Telephone: +1 330 682 7015
Mast Customer Service: +1 330 684 4000
Fax: +1 330 684 1190
Email: info@willburt.com

**INTEGRATED TOWER SYSTEMS
A WILL-BURT COMPANY**

2703 Dawson Road, Tulsa, OK 74110
Telephone: +1 800 850 8535
Fax: +1 918 749 8537
Email: programs@itstowers.com

**WILL-BURT
GERMANY**

Fischergasse 25
D-91344 Waischenfeld
Germany
Telephone: +49 9202 180
Fax: +49 9202 1811 / Email: info@willburt.com

**WILL-BURT ASIA
SINGAPORE SALES OFFICE**

1 Fullerton Road, #02-01 One Fullerton,
Singapore 049213
Telephone: +65 6832 5689
Fax: +65 6722 0664 / Email: info@willburt.com

**WILL-BURT
UNITED KINGDOM**

Unit 5b, Station Approach
Four Marks, Alton Hampshire,
GU34 5HN, United Kingdom
Telephone: +44 (0) 1403 265532
Fax: +44 (0) 1403 259072 / Email: info@willburt.com

**WILL-BURT
TURKIYE**

Ahi Evran OSB Mahallesi,
Nahcivan Caddesi, No: 8/2,
Sincan, Ankara 06935
Email: info@willburt.com

The Will-Burt Company, headquartered in Orrville, Ohio, USA, is the world's premier manufacturer of mobile telescoping masts, towers and pan and tilt positioners. We offer virtually every mobile payload elevation and integration solution for defense, government, first responders, cellular and mobile, broadcast, energy production and other markets. Will-Burt also offers contract manufacturing, metal fabrication, powder-coating, and rapid prototyping services. Will-Burt is an international company with offices and manufacturing in the USA, England, and Germany along with offices in Singapore and a joint venture in Turkey. All Will-Burt Company manufacturing locations are backed by a certified ISO 9001:2015 Quality Management System. Incorporated in 1918, Will-Burt is 100% employee-owned and is classified as a small business.